

DYNAMIC CONFORMATIONAL AND EXCHANGE
PROCESSES IN 2-(4'-PYRIDYL)BENZAZOLES

Claude Marzin^{*} and Michael E. Peek, Centre de Chimie Organique,
Université des Sciences et Techniques du Languedoc, Place E. Bataillon,
34060 Montpellier Cedex, France.

José Elguero, Laboratoire de Chimie Moléculaire, Université
d'Aix-Marseille III, Rue H. Poincaré, 13397 Marseille Cedex 4, France,

Hubert P. Figeys and Nicole Defay, Service de Chimie Organique,
Université Libre de Bruxelles, Avenue F. Roosevelt 50, Bruxelles,
Belgique.

Adress to which the proof should be mailed: Dr. Claude Marzin, Centre de Chimie Organique, Université des Sciences et Techniques du Languedoc, Place E. Bataillon, 34060 Montpellier Cedex, France.

ABSTRACT - The barrier to the rotation about the C-C bond linking the two heterocycles of 2-(4'-pyridyl)benzazoles and of their pyridinium salts is too low to be measured by proton nmr spectroscopy at 60 MHz. A slowing down of the proton exchange between the two benzimidazole nitrogen atoms has been shown to occur. The conformation of the different molecules is discussed.

From the Kauffmann's arenology principle (1) compounds B, C and D (see scheme 1) must show a restricted rotation about the central bond. For compounds B, the barriers to rotation about the exocyclic C-C bond of various C-formylated or C-acetylated pyrroles, furans and thiophenes are well known (2 to 7 for example); recently the rotational barrier in 4-formylpyrazole has been measured (8). Less attention has been given to the corresponding barriers in compounds of type C (9 to 11); however it has been possible to show that the presence of electron-withdrawing substituents or of added nitrogen atoms in the ring raises the barriers. In the first part of the present work we describe the first attempt to determine the activation energy of rotation about a bond linking two heterocycles, one being π -rich and the other π -deficient (type D)

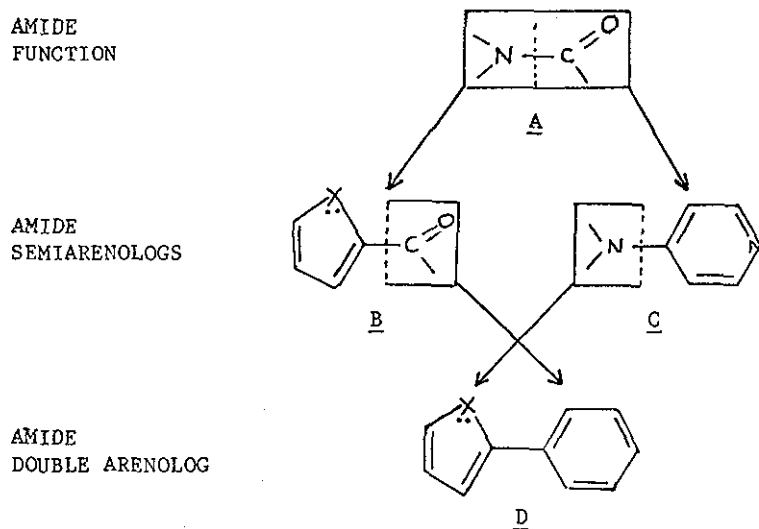

Scheme 1 : Application of the arenology principle to the case of amides

All these cases are concerned with the rotation about a formal single-bond between two sp^2 -hybridized atoms. These compounds have two rotational barriers: one I has a σ origin and is due to an increase of the steric effects near the planar state ($\varphi = 0^\circ$), the other, II, π -originated, arises from a loss of delocalization energy near the

orthogonal intermediate state ($\varphi = 90^\circ$). This last barrier is the only one which can be measured by NMR spectroscopy, as the rotation permutes the signals arising from A and B.



In the case of the amides A, the main barrier has clearly a π -origin and thus can be obtained from NMR measurements; but in the case of compounds D, the problem is to determine which barrier is the higher one. Except for compounds in which $X=NR$ with a bulky R group (a methyl for example), one may admit that the rotational barrier through a planar transition state, is equal or inferior to the biphenyl barrier for which $\Delta G_I^\ddagger = 2.5$ Kcal/mole (12).

The following compounds belonging to class D, 1 to 10, have been chosen for the present NMR study:

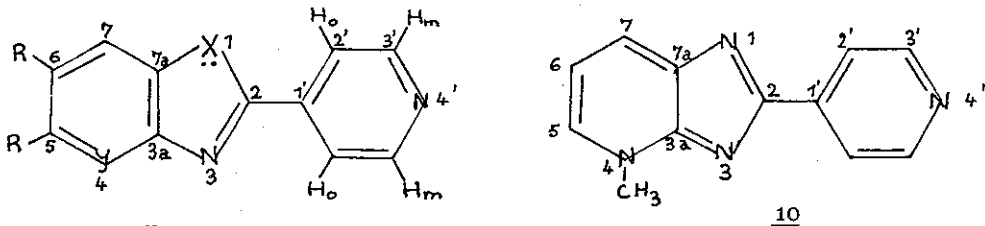

	X	Y	R
<u>1</u>	NH	CH	H
<u>2</u>	N-CH ₃	CH	H
<u>3</u>	N-C ₆ H ₅	CH	H
<u>4</u>	NH	CH	CH ₃
<u>5</u>	N-CH ₃	CH	CH ₃
<u>6</u>	NH	N	H
<u>7</u>	N-CH ₃	N	H
<u>8</u>	O	CH	H
<u>9</u>	S	CH	H

The values of the proton chemical shifts are given in table 1. The four pyridinic protons always give rise to an AA'BB' system [the protons α to the nitrogen atom appear at higher frequencies and their signals are broadened by the quadrupolar relaxation of the adjacent nitrogen] : this shows that, either the rotation about the C-C bond is fast at room temperature [assuming that the non-equivalence produced by the sp^2 nitrogen atom and the X group of the five-membered ring is sufficient to make the two protons H_o anisochronous when the two rings are not orthogonal] or that the two rings are perpendicular. This problem is similar to that of the atropoisomerism where the two phenyl rings become perpendicular only if the four ortho positions are substituted. The molecules described here have at most one ortho substituent, therefore the energy of the coplanar "configuration" must not be high enough to prevent the interconversion. This is in agreement with Bergmann et al. (13) who assumed a fast rotation of the phenyl group in 8-phenylpurines at room temperature. Various factors may influence the value of the barrier to the rotation about the bond linking the two heterocycles:

i- the conjugation between the benzazolic and pyridinic rings which leads to an increase of the barrier; this conjugation depends on the electron-donating character of the benzazole ring and on the electron-accepting character of the pyridinic ring and thus on their substituents. However the existence of such a conjugation destroys the benzenic structure of the benzazole ring making it unfavourable.

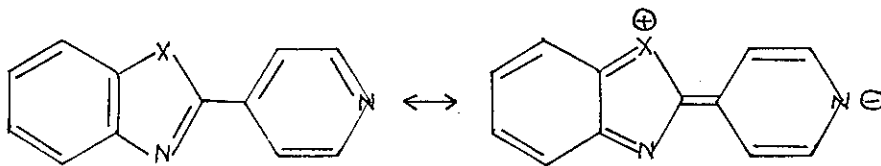

ii- the steric hindrance between the protons H_o and X, which decreases the barrier because of an increase in the energy of the planar state [if X is O or S, however, an attraction can occur between the lone pairs and the aromatic protons]

From the values of the Hammett σ_1 and σ_R constants in 2-phenylbenzazoles (14) it can be concluded that conjugation should be favoured in compounds 2, 5 and at a lesser extent in 3 as well as in 7 in which the nitrogen in the fused benzene ring has an electron-withdrawing character (11); unfortunately these compounds are those for which the steric hindrance (factor ii) is more important.

We have undertaken a PMR study at low temperature¹ of compounds 2 (in acetone- d_6 down to -90°C and in THF down to -80°C), 3, 7, 8, 9 (in THF down to -100°C) and 10 (in a mixture THF/acetone- d_6 down to -100°C): no changes in the spectra have been observed; however the spectrum of compound 5 starts to show a broadening of the signals which is more important for protons H_o than for protons H_m at -80°C in THF; unfortunately it was impossible to reach temperatures lower than -90°C . An attempt to observe this phenomenon on the ^{13}C spectrum of compound 2 in acetone- d_6 failed because of its insolubility at low temperature (^{13}C chemical shifts are given together with those of compound 4, in the paragraph concerned with the exchange process occurring in NH benzimidazole derivatives).

In the case of the quaternary salts 11 to 16, the possibility of conjugation between the benzazolic and pyridinic rings is higher than in the bases:

	X	R
<u>11</u>	NH	H
<u>12</u>	NCH ₃	H
<u>13</u>	NC ₆ H ₅	H
<u>14</u>	NH	CH ₃
<u>15</u>	O	H
<u>16</u>	S	H

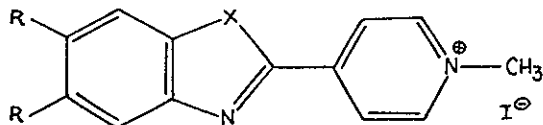

The proton chemical shifts measured for these salts are given in table 2. Conjugation should be most favourable in compounds 15 or 16 for which steric hindrance is minimum: however cooling a solution of 15 in liquid SO_2 down to -70°C showed no change in the NMR spectrum.

¹ In all cases, a sharpening of the signals due to the H_m protons, is observed because of the increase of the nitrogen relaxation rate when the temperature is lowered (15).

It therefore seems very difficult to reach the rotational barrier about the C-C bond of molecules of type D by NMR spectroscopy. However we can try to estimate its magnitude in assuming, as in the Hammett equation, that the logarithm of the rate of rotation about the amidic bond (and thus the activation energy²) can be expressed as the product of two terms, α and β , each one corresponding to one part of the molecule, respectively electron-donating and electron-attracting. The simplified results obtained from experimental values using a non-linear regression are given in table 3 and they show that one can expect barriers of approximately 4 Kcal/mole for compounds of type D. These values are thus too low to be reached by the method we used (proton NMR at 60MHz above -100°C).

In that procedure we have supposed that the α values were similar in compounds 17 and 18. In order to get a more realistic estimation of the α coefficient in our compounds we have prepared the 2-formylbenzimidazoles 19 and 20 with the purpose of measuring their rotational barriers (their α coefficient would be equal to $\Delta G^*/5.5$)

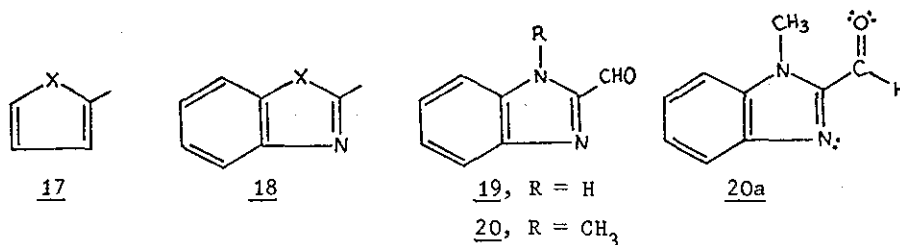

Unfortunately the 2-formylbenzimidazole 19 could not be studied at low temperature as it exists as a dimer at ambient temperature (18). In order to observe the proton spectrum of the monomer we had to warm up to +110°C in DMSO-d₆. In the case of compound 20 even at -125°C in a mixture CHCl₂F/CH₂Cl₂ no change was observed on the signal due to the formyl proton: this does not necessarily show that the barrier to the rotation of the C-CHO bond is low, but rather that this molecule exists mainly in the planar or near planar conformation 20a, because of the repulsion between the lone pairs of the oxygen and nitrogen (N₃) atoms.

² For instance it has been shown (35a) that the rotation barrier of p-substituted benzamides correlates with Hammett's constants.

Exchange process.

Usually the NH proton of a benzimidazole ring exchanges rapidly between the two nitrogen atoms so that one can expect to observe in NMR spectroscopy, an AA'BB' or an A₂ system for the benzenic protons of the benzimidazoles 1 and 4 respectively. However, this exchange has been slowed down at low temperature in THF in the case of the 2-chloro-benzimidazole and of its 6-methoxy derivative (19); moreover from proton and carbon-13 experiments it has been possible to observe a slow exchange at ambient temperature (20) in the case of the 2,2-dimethyl-3-(2'-benzimidazolyl) ethylpropanoate in CDCl₃ and DMSO-d₆.

The proton spectrum of compound 4, taken in DMSO-d₆ at 60 MHz, shows that the signal due to the protons H-4 and H-7 is abnormally broadened even after decoupling of the methyl groups. The carbon-13 spectrum shows this phenomenon even more clearly (C-13 chemical shifts are shown below, together with those of compound 2):

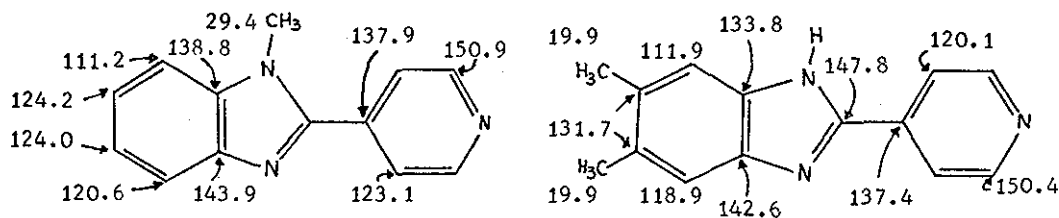

2 in acetone-d₆

1 in DMSO-d₆

Carbons at positions 3a and 4a, 4 and 7 are anisochronous³ though still broadened as the exchange is not slow enough on the NMR scale; carbons at positions 5 and 6 are not anisochronous enough to give rise to two distinct signals but their peak is broadened.

Thus it seems that the proton exchange between the two nitrogen atoms is easier to observe in a benzimidazole system than in other heteroaromatic rings (21-25).

It can be noted that carbons α to the pyridinic nitrogen as well as carbons β are isochronous showing that there is no restricted rotation about the C-C bond linking the two heterocycles.

³ All the assignments have been made from off-decoupling or selective decoupling experiments or by comparison with attributions already made on similar systems (20).

Torsion angle between the pyridine ring and the benzazole plane.

Some authors (13) have recently attempted to calculate the angle between the planes of the phenyl and purine rings of a series of 8-phenylpurines. They used the difference in chemical shifts of the ortho and meta phenyl protons assuming that it was only due to the purine ring current effect⁴. In all their calculations they neglected the anisotropy effects of the sp^2 nitrogen and of the N-R group in the imidazole ring.

In the case of our systems the difference in chemical shifts between ortho and meta protons of the pyridine nucleus arises, on the one hand from the pyridinic nitrogen, and on the other from the benzazole effect (ring current and substituent effects).

From a comparison with the chemical shifts of pyridine itself [$\delta_{H-2,6} = 8.60$ ppm, $\delta_{H-3,5} = 7.25$ ppm in $CDCl_3$ (26)] it can be observed (see table 1) that meta protons H_m are slightly shifted ($S_m = 0.00-0.20$ ppm) whereas ortho protons H_o are more strongly shifted ($S_o = 0.40-1.05$ ppm) towards high frequencies by the introduction of a benzazole ring. The effect on meta protons has the same order of magnitude as that observed for the aryl protons when an azole is introduced in N-arylazoles (27); for the ortho protons the shifts due to the benzazole ring (this work) are more important than those produced by an azole ring [N-arylazoles (27)]. In both cases, compounds can be classified into three classes:

Class a : ortho protons face two sp^2 nitrogen atoms as in compound 10 ($S_o = 1.05$ ppm).

Class b : ortho protons face one sp^2 nitrogen and a group bearing no bulky substituent as in compounds 1,8 and 9 ($0.60 < S_o < 0.78$ ppm). It is interesting to notice that a sulphur atom, in compound 9, shifts the ortho protons less towards high frequencies than an NH group or an oxygen atom.

Class c : ortho protons face one sp^2 nitrogen and a NR group as in 2, 5 and 7 ($0.40 < S_o < 0.50$ ppm).⁵

⁴ The authors (13) have calculated that the effects expected from changes in the carbon charges should be very small.

⁵ The difference between series b and c appears also in carbon-13 spectroscopy: carbon 2' of compound 1 resonates at 120.1 ppm whereas that of compound 2 resonates at 123.1 ppm; this shift occurs certainly because of a noticeable increase of the dihedral angle in compound 2 (class c).

If we now consider the difference of chemical shifts $\Delta = \delta_{H_m} - \delta_{H_o}$ in every 2-(4'-pyridyl) benzazole (see table 1), the same classification is obtained:

Class a : compound 10; $\Delta = 0.45$ ppm

Class b : compounds 1, 4, 6, 8 and 9; $0.66 < \Delta < 0.85$ ppm

Class c : compounds 2, 5 and 7; $\Delta = 1.06$ ppm

First, one can notice that ortho protons in compounds 8 and 9 though facing two lone pairs behave like protons of NH derivatives. Going from class a to classes b and c, ortho protons are shifted towards low frequencies: this arises because of the enhanced steric hindrance which changes the dihedral angle between the two heterocyclic planes in the favoured conformation and thus makes the ring current effect less important. Two other factors can influence the ring current itself: the loss of conjugation between the two heterocyclic moieties when the steric hindrance increases, and the introduction of a substituent (28). Besides the effect of the ring current on the ortho protons of the pyridinic nucleus, one must also consider the influence of the lone pairs of the benzazole heteroatom and of the N-substituent. At this stage it is impossible to separate all these effects but studies are in progress to do so, especially in order to reach the value of the torsion angle between the heterocyclic rings in the three classes of compounds.

If our estimations of ΔG_I^* (~ 2 Kcal/mole) and ΔG_{II}^* (~ 4 Kcal/mole) are correct, the potential energy curve as a function of the torsional angle, will have the following feature for compounds of class b :

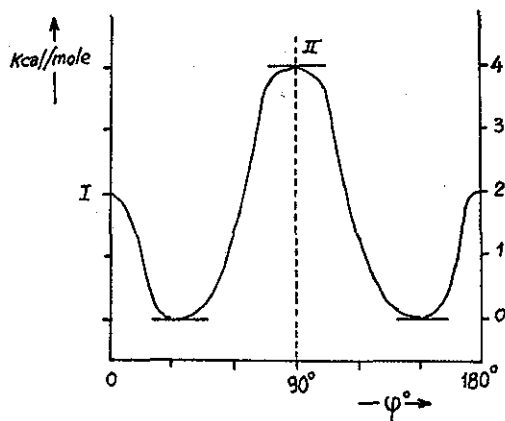
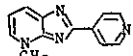

Table 1 : Proton NMR data for a series of 2-(4'-pyridyl) benzazoles^a

Compound	X	Y	R	Solvent	H _m	S _m ^b	H _o	S _o ^b	H ₄	H ₇	H ₅	H ₆	X(Y)	Δ ^c
<u>1</u>	NH	CH	H	CDCl ₃	8.75	+0.15	7.98	+0.73	7.70		7.36			0.77
				THF	8.65		7.93		7.55		7.16			0.72
				DMSO-d ₆	8.80		8.12		7.70		7.30			0.68
<u>2</u>	NCH ₃	CH	H	CDCl ₃	8.76	+0.16	7.69	+0.44	7.84	7.20-7.36	3.88	1.07
				THF	8.68		7.72		7.54	7.22		0.96
				DMSO-d ₆	8.77		7.86		7.64	7.29	3.93	0.91
<u>3</u>	NC ₆ H ₅	CH	H	CDCl ₃	8.52	-0.08			7.86	7.16-7.55		
				THF	8.48				7.66	7.20-7.55		
<u>4</u>	NH	CH	CH ₃	DMSO-d ₆	8.71		8.05		7.45		2.36			0.66
				THF	8.60		7.94		7.30					0.66
<u>5</u>	NCH ₃	CH	CH ₃	CDCl ₃	8.71	+0.11	7.65	+0.40	7.57	7.13	2.39	2.41	3.83	1.06
				CDCl ₃ /THF	8.69		7.70		7.48	7.18				0.99
<u>6</u> ^d	NH	N	H	DMSO-d ₆	8.89		8.20		8.12		8.48	7.30		0.69
				THF	8.70		8.00		7.95		8.30	7.16		0.70
<u>7</u> ^d	NCH ₃	N	H	CDCl ₃	8.80	+0.20	7.75	+0.50	8.10		8.45	7.22		1.05
				THF	8.79	8.05	7.77	7.20-7.60				0.73
<u>8</u>	O	CH	H	CDCl ₃	8.76	+0.16	8.03	+0.76	7.77		7.20-7.60		0.73
				THF						7.30-7.86		0.74
<u>9</u>	S	CH	H	CDCl ₃	8.70	+0.10	7.85	+0.60	8.04	7.20-7.55		0.85
<u>10</u> ^e				CDCl ₃	8.75	+0.15	8.30	+1.05	8.28		7.65	7.06	(4.34)	0.45

^a In the case of AA'BB' and ABCD proton systems, corresponds to the center of the multiplet.

^b S_o and S_m: chemical shift differences between a pyridinic proton, having the same position in the 2-(4'-pyridyl) benzazoles considered, and in pyridine itself.

^c Δ = δ(H_m) - δ(H_o): difference of chemical shifts between meta and ortho protons in 2-(4'-pyridyl) benzazoles.

^d δ (DMSO-d₆) J_{H-5, H-6} = 5.0 Hz; J_{H-6, H-7} = 8.0 Hz; J_{H-5, H-7} = 1.5 Hz.

J (CDCl₃) J_{H-5, H-6} = 4.9 Hz; J_{H-6, H-7} = 8.0 Hz; J_{H-5, H-7} = 1.4 Hz.

^e J_{H-5, H-6} = 6.0 Hz; J_{H-6, H-7} = 7.6 Hz; J_{H-5, H-7} = 0 Hz. Assignments have been made using the values obtained for imidazo[4,5-b]pyridine (29).



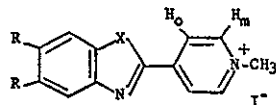

















Table 2 - Proton NMR data for a series of 2- (4'-pyridyl) benzazole salts.



Compound	X	R	Solvent	H _m	H _o	H ₄	H ₇	H ₅	H ₆	X	NCH ₃	Δ ^a
<u>11</u>	NH	H	DMSO-d ₆	9.12	8.66	7.71		7.37				0.46
<u>12</u>	NCH ₃	H	"	9.11	8.60	7.77		~ 7.35		4.05	4.39	0.51
<u>13</u>	NC ₆ H ₅	H	"	8.79	8.00	-----	7.21 - 7.95	-----		7.60	4.15	0.79
<u>14</u>	NH	CH ₃	"	8.94	8.46	7.36		2.30			4.25	0.48
<u>15</u>	O	H	"	9.20	8.71	~ 7.93		~ 7.61			4.45	0.49
<u>16</u>	S	H	"	9.11	8.70	~ 8.25		~ 7.60			4.33	0.41

^aΔ = δ (H_m) - δ (H_o) = difference of chemical shifts between meta and ortho protons.

Table 3 - Experimental and estimated energetic parameters.

Compound	Experimental values Kcal/mole	$\Delta G^* = \alpha \times \beta$ Kcal/mole	α	β
A 	19-22 (16)	$4 \times 5.5 = 21$		 5.5
B 	9-12 (2)	$2 \times 5.5 = 11$		 5.5
C 	8 (17)	$2 \times 4 = 8$		 2
	10.7 (35b)	$2 \times 5.5 = 11$		 5.5
	12 (35c)	$2 \times 6 = 12$		 6
	23 (36)	$4 \times 6 = 24$		 6
D 	?	$2 \times 2 = 4$		 2

Therefore one can expect that ΔG_{II}^* could be measured by NMR spectroscopy using either the proton resonance at high field, or the ^{13}C resonance at temperatures around -150°C .

This is not valid for compounds belonging to class c in which ΔG_I^* can be higher than ΔG_{II}^* because of the steric effects due to the nitrogen substituent.

Acknowledgment: We are grateful to Professor J. Sandström (Chemical Center, University of Lund) for having taken several proton NMR spectra at low temperature.

EXPERIMENTAL PART

Proton NMR spectra have been recorded on a Varian A60 spectrometer equipped with a variable temperature controller. The carbon NMR spectra have been recorded on a Brücker WP60 operating at 15.08 MHz, the field being locked on the ^2H resonance of the solvent.

2-(4'-pyridyl) benzimidazole 1

This compound was prepared by two different ways:

- by heating o-phenylenediamine with isonicotinic hydrazide at 250°C for 8 hours. This is a modification of the process used by Hideg and Hankovsky (30) which did not give the described yield. Yield 50 %.

- by condensation of 0.1M of o-phenylenediamine with 0.1M of isonicotinic acid at $150-160^\circ\text{C}$ in a bomb with 10 ml 35% HCl for 7 hours. The solid product was washed thoroughly with water, dried and washed with chloroform. Yield 75%.

m.p.(aqueous ethanol) = $224-225^\circ$ [Lit., $225-226^\circ$ (30)]

2-(4'-pyridyl)-5,6-dimethylbenzimidazole 4

This compound was obtained by heating the 1,2-diamino-4,5-dimethylbenzene with isonicotinic hydrazide at 250°C for 7 hours. The product was taken up with water, filtered, dried and washed with ether. Yield 81%.

m.p.(ethanol) = $241-243^\circ$

2-(4'-pyridyl) benzoxazole 8 and benzothiazole 9

The method described by Hideg and Hankovsky (30) was used.

8 m.p. (ethanol) = 139-140° [Lit., 137-138° (30)]

9 m.p. (acetone) = 135-136° [Lit., 136-137° (30)]

2-(4'-pyridyl)-4-azabenzimidazole 6

This compound was synthesised by heating at 210-230° for 3 hours a mixture of 2,3-diaminopyr^{di}idine and isonicotinic hydrazide. The product was taken up with water, filtered and dried. Yield 80%.

m.p. (ethanol) 260-262°

N-methylation of the 2-(4'-pyridyl) benzimidazoles

The NH compound (1mmole) was heated at 55-60° for 1 hour in methanol (20 ml) with two pellets of sodium hydroxide. The mixture was stirred and dimethylsulphate (1.5 mmole) was added dropwise. The product was tipped into 500 ml of water, extracted with chloroform, dried (K₂SO₄) and evaporated. Chromatography on alumina gave the expected product:

2 (eluent:CHCl₃) m.p. = 105-106° (Yield 30%)

5 (eluent: ether-petrol 50/50) m.p. = 216-217° (Yield 20%)

The same procedure was used to methylate the 2-(4'-pyridyl)-4-azabenzimidazole. But by chromatography on alumina two products could be separated:

7 (eluent: CHCl₃/ether 50/50) m.p. = 115-116° (Yield 10%)

10 (eluent: CHCl₃) m.p. = 209° (Yield 20%)

Direct synthesis of compound 2

N-methyl o-phenylenediamine (0.01M) and isonicotinic hydrazide (0.01M) were heated under reflux with a gas outlet, at 230-240° for 3 hours. The crude product was cooled, dissolved in acetone and evaporated; the residue was triturated with ether-petrol to remove traces of the diamine and then with water to remove the hydrazide giving a solid which was filtered and dried.

m.p. (aqueous ethanol) = 105-106° (Yield 80%)

N-phenyl 2-(4'-pyridyl) benzimidazole 3

N-phenyl o-phenylenediamine (0.01M) and isonicotinic hydrazide (0.01M) were heated at 210-230° for 6 hours. The product was cooled, taken up in hot ethanol and evaporated. Trituration with water gave a solid which was filtered and dried.

Chromatography on alumina (eluent: ether) gave:

3 m.p. = 142-143° (Yield 20%)

Quaternization of 2-(4'-pyridyl) benzazoles

The benzazole (1 mmole) was heated under reflux for 2 hours with methyl iodide (3 mmoles) in acetone (10 ml). The solution was cooled and filtered; the solid was washed with chloroform and re-crystallized from ethanol:

11 m.p. = 270-271° (Yield 82%)

12 m.p. = 283-284° (Yield 70%)

13 m.p. = 233-234° (Yield 74%)

14 m.p. = 303-304° (Yield 92%)

15 m.p. = 320-322° (Yield 95%)

16 m.p. = 311-312° (Yield 90%)

2-Formylbenzimidazole 19

The 2-hydroxymethylbenzimidazole (31) was oxidised by SeO_2 according to the method reported by Campaigne, Thompson and Van Werth (32) to give the 2-formylbenzimidazole. Yield 41%.

19 m.p. = 234-235° Lit., 235° (33)

1-methyl-2-formylbenzimidazole 20

The procedure described by Le Bris and Wahl (34), starting with 1,2-dimethylbenzimidazole, was used :

20 m.p. = 121-122° Lit., 123.5° (18)

REFERENCES

- 1 T. Kauffmann, Angew. Chem. Int. Ed., 1971, 10, 743.
- 2 L. Arlinger, K-I. Dahlqvist and S. Forsen, Acta Chem. Scand., 1970, 24, 672.
- 3 M.C. Fournié-Zaluski, C. Jaureguiberry and B. Roques, Tetrahedron Letters, 1973, 4177; B. Roques, S. Combrisson and F. Wehrli, Tetrahedron Letters, 1975, 1047.
- 4 K-I. Dahlqvist and S. Forsen, Acta Chem. Scand., 1970, 24, 662.
- 5 K-I. Dahlqvist, Acta Chem. Scand., 1970, 24, 683.
- 6 S. Combrisson, B. Roques, P. Rigny and J.J. Basselier, Canad. J. Chem., 1971, 49, 904.
- 7 B. Roques, S. Combrisson, C. Riche and C. Pascard-Billy, Tetrahedron, 1970, 26, 3555.
- 8 J. Elguero, C. Marzin and M. Peek, Bull. Soc. Chim. Belges, 1975, 499.
- 9 A. R. Katritzky and G. J. T. Tiddy, Org. Magn. Res., 1969, 1, 57
- 10 J. Almog, A.Y. Meyer and H. Shanan-Atidi, J. Chem. Soc. (Perkin II), 1972, 451.
- 11 T. Liljefors, Org. Magn. Res., 1974, 6, 144.
- 12 H.-J. Hofmann and P. Birner, Z. Chem., 1975, 15, 23.
- 13 F. Bergmann, I. Tami, Z. Neiman and D. Lichtenberg, Tetrahedron, 1974, 30, 3045.
- 14 V.F. Bystrov, Zh.N. Belaya, B.E. Gruz, G.P. Syrova, A.I. Tolmachev, L.M. Shulezhko and L.M. Yagupol'skii, J. gen. Chem. (URSS), 1968, 38, 963.
- 15 J.M. Lehn and J.P. Kintzinger, "Nitrogen NMR" eds. by M. Witanowski and G.A. Webb, Plenum Press, 1973, 148.
- 16 H. Kessler, Angew. Chem. Int. Ed., 1970, 9, 219.
- 17 D.D. MacNicol, Chem. Comm., 1969, 933.
- 18 H.R. Hensel, Chem. Ber., 1965, 98, 1325.
- 19 R. Benassi, P. Lazzeretti, L. Schenetti, F. Taddei and P. Vivarelli, Tetrahedron Letters, 1971, 3299.
- 20 J. Elguero, G. Llouquet and C. Marzin, Tetrahedron Letters, 1975, 4085.

- 21 L.T. Creagh and P. Truitt, J. Org. Chem., 1968, 33, 2956.
- 22 M.L. Roumestant, P. Viallefont, J. Elguero and R. Jacquier, Tetrahedron Letters, 1969, 495.
- 23 A.N. Nesmeyanov, V.N. Babin, L.A. Fedorov, M.I. Rybinskaya and E.I. Fedin, Tetrahedron, 1969, 25, 4667.
- 24 A.N. Nesmeyanov, E.B. Zavelovich, V.N. Babin, N.S. Kochetkova and E.I. Fedin, Tetrahedron, 1975, 31, 1461.
- 25 A.N. Nesmeyanov, V.N. Babin, E.B. Zavelovich and N.S. Kochetkova, Chem. Phys. Letters, 1976, 37, 184.
- 26 T.J. Batterham "NMR Spectra of Simple Heterocycles" eds. by E.C. Taylor and A. Weissberger, Liley-Intersciences, 1973, p. 10.
- 27 J. Elguero, R. Jacquier and S. Mondon, Bull. Soc. Chim. Fr., 1970, 1346.
- 28 H.P. Figeys and R. Flammang, Mol. Phys., 1967, 12, 581.
- 29 J. Elguero, A. Fruchier and S. Mignonac-Mondon, Bull. Soc. Chim. Fr., 1972, 2916.
- 30 K. Hideg and O.H. Hankovsky, Acta Chim. Hungar., 1965, 43, 263.
- 31 A. Bistrzycki and G. Przeworskii, Ber., 1912, 45, 3483.
- 32 E. Campaigne, R.L. Thompson and J.E. Van Werth, J. Med. Pharm. Chem., 1959, 1, 577.
- 33 C.F. Heubner, R. Lohman, R.J. Dimler, S. Moore and K.P. Link, J. Biol. Chem., 1945, 159, 503.
- 34 M-T. Le Bris and H. Wahl, Bull. Soc. Chim. Fr., 1959, 343.
- 35 L.M. Jackman and E.A. Cotton, "Dynamic Nuclear Magnetic Resonance Spectroscopy" Academic Press Inc., New York, 1975, (a) p. 210, (b) p. 181, (c) p. 190.
- 36 G. Binsch, "Topics in Stereochemistry" eds. by E.L. Eliel and N.L. Allinger, Interscience, 1968, Vol. 3, p. 138.

Received, 22nd March, 1977