

## 2'-SUBSTITUTED 2'-DEOXPURINENUCLEOTIDES THEIR CONFORMATION AND PROPERTIES

Morio Ikehara

Faculty of Pharmaceutical Sciences, Osaka University, 1-6, Yamada-Oka, Suita,  
Osaka 565, Japan

**Abstract** — In order to investigate the structure-function relationship of DNA and RNA, a number of nucleotide analogs having various substituents in the 2'-position of purine nucleoside moieties were synthesized and their physical and biological properties investigated.

It is of considerable interest to investigate the structure-function relationship of DNA and RNA, which are different chemically only in the absence or presence of the OH group in the 2'-position of the carbohydrate moiety. In this connection, we synthesized a number of analogs of 2'-substituted purine nucleosides, nucleotides, oligonucleotides and polynucleotides and investigated their physico-chemical as well as biological properties.

As reported previously<sup>1</sup>, we are able to synthesize 2'-substituted purine nucleosides easily and in quantity through 8-cyclonucleosides.<sup>2</sup> The synthetic pathway for 2'-fluoro-2'-deoxyadenosine is shown in Chart 1. Starting from easily available adenosine, a cyclonucleoside, 8,2'-anhydro-8-oxy-9-β-D-arabinofuranosyladenine (**4**) is obtainable in a yield of ca. 40 %. The compound **4** is derived through 3',5'-protected 9-β-D-arabinofuranosyladenine (araA)(**8**) to 2'-fluoro compound in ca. 8 % overall yields. Other analogs having azido, amino, chloro, bromo and iodo substituents can be obtained analogously. Introduction of the tetrahydrofuranyl (Thf) rather than the tetrahydropyranyl (Thp) group in the compound **8**, increased the yield to ca. 20 %.<sup>3</sup>

Guanosine and inosine derivatives containing 2'-fluoro, chloro, bromo, azido and amino groups have been synthesized analogously to compare their properties with adenosine derivatives.<sup>4</sup> Among them, 2'-amino-2'-deoxyguanosine was found as an antibiotic in *Enterobacter cloacae* by Nakanishi et al.<sup>5</sup> It showed antibacterial and anticancer activities. After the chemical synthesis of 2'-amino-2'-deoxyadenosine, this compound was also found as an antibiotic from *Actinomycetes* sp. 372-Av<sub>1</sub> showing some anticancer activity.<sup>6</sup> This is another case finding a naturally occurring active compound after its chemical synthesis, as in the case of aristeromycin. Other groups of chemists also synthesized these types of 2'-substituted purine nucleoside through the conversion of the carbo-

hydrate moiety of pyrimidine nucleoside to the purine,<sup>7</sup> inversion of araA triflate,<sup>8</sup> or the condensation of purines to preformed carbohydrate moieties.<sup>9</sup>

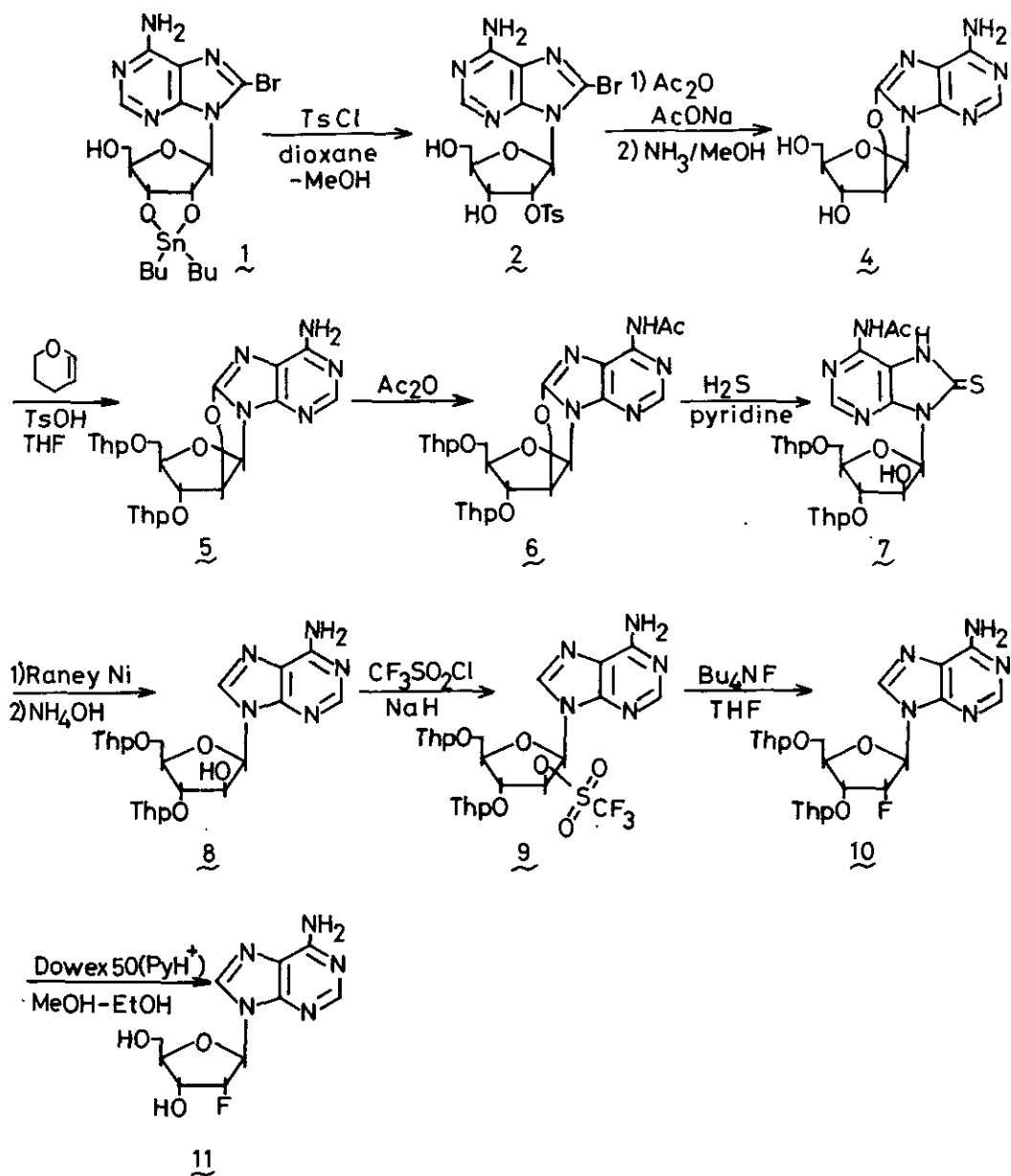

We then investigated the physical properties of these 2'-substituted nucleoside by UV,  $^1\text{H}$ - and  $^{13}\text{C}$  NMR, as well as by X-ray crystallography.

When  $^1\text{H}$ -NMR of adenosine derivatives were taken, we found that coupling constants (J) between 1'-H and 2'-H lined up with the electronegativity of 2'-substituents as shown in Table I.<sup>10</sup>

Table I Vicinal H-H coupling constants (Hz) and conformation of adenosine derivatives.

Compound	$J_{1'2'}$	$J_{2'3'}$	$J_{3'4'}$	$J_{1'2'+3'4'}$	Population of N conformer (%)
	6.2	3.0			
2'-H	7.7	5.6			19
OH	6.7	5.7	3.1	9.2	36
$\text{NH}_2$	7.5				21
$\text{OCH}_3$	5.5				42
$\text{N}_3$	5.9				38
F	3.1	4.3	6.0	9.1	67
Cl	7.2	4.8	2.7	9.9	24
Br	7.4	4.7	2.4	9.8	22
I	8.8	4.5			7

Assuming that the furanose puckering is an equilibrium between 3'-endo and 3'-exo forms<sup>11</sup>, as illustrated in Fig. 1, the coupling constants  $J_{1'2'}$ , may reflect the amount of one conformation in the sum of two conformers. This can be clearly observed in Fig. 2, when the population of N-conformation was plotted against  $\chi$ , a negativity coefficient. All compounds lined up beautifully on a curve, suggesting that the electronegativity of substituents determined the conformation of the carbohydrate moiety of 2'-substituted nucleosides. This point was also suggested by Guschlbauer et al. using pyrimidine nucleosides.<sup>12</sup>

The same conclusion was obtained by studies of 2'-deoxyguanosine derivatives with  $^1\text{H}$ -NMR<sup>4</sup> as summarized in Table II. Again, electronegativity of 2'-substituents governs conformation of guanosine nucleosides, and the tendency is rather clearer than in the case of adenosine derivatives.

Table II Coupling constants (Hz) and conformation of guanosine derivatives.

Compound	$J_{1'2'}$	$J_{2'3'}$	$J_{3'4'}$	$J_{1'2'+3'4'}$	Population of N conformer (%)
2'-F	2.8	4.1	6.3	9.1	69
Cl	6.9	4.8	3.0	9.9	30
Br	7.6	4.8	2.2	9.8	22
I	8.7	4.6			13

Fig. 1

# Equilibrium in Furanose Puckering

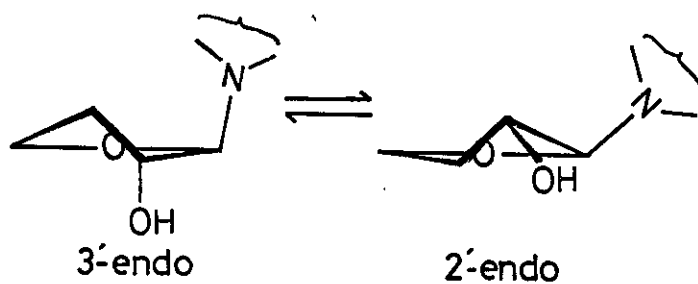
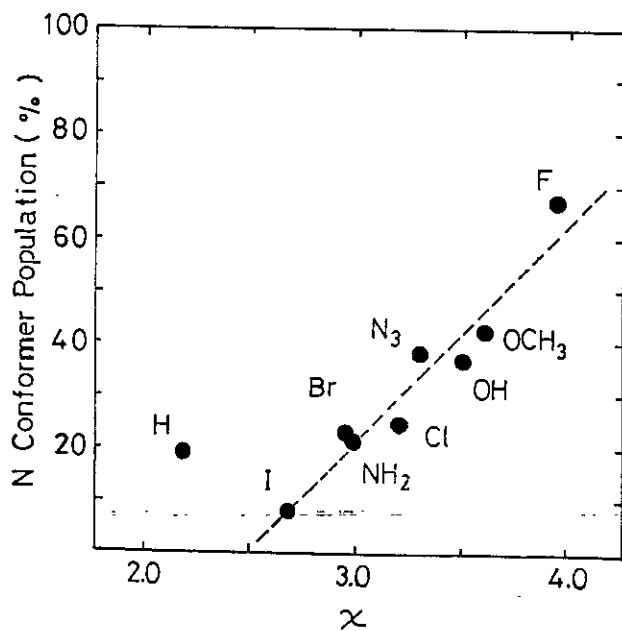
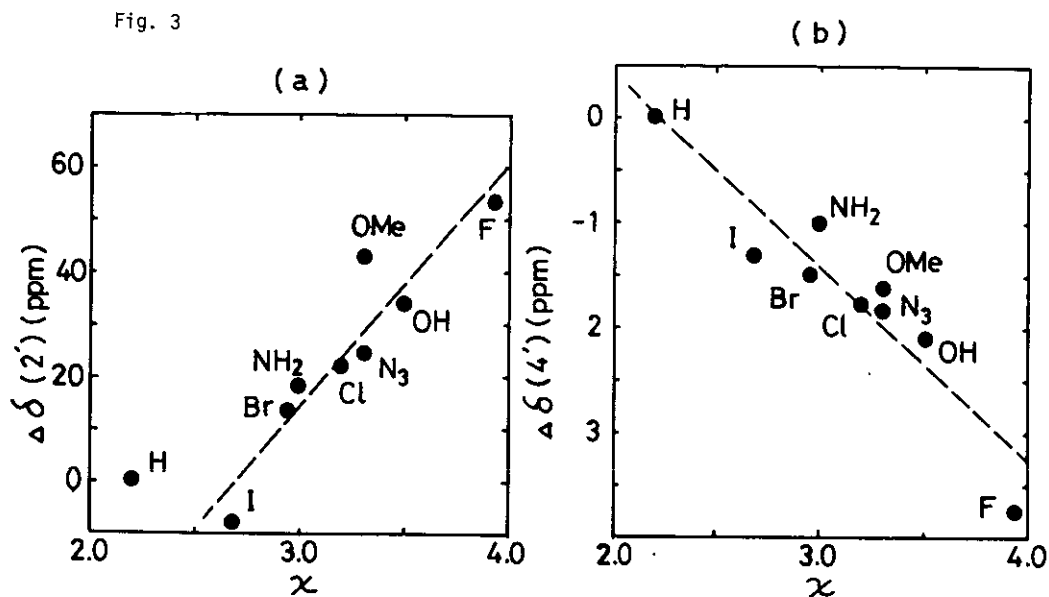

Fig. 2



In order to correlate the electronegativity (inductive effect) of the 2'-substituent and the chemical shift of adenosine derivatives, we examined  $^{13}\text{C}$  NMR of these compounds.<sup>13</sup> When the difference in chemical shift of the 2' and 4'-C atoms of 2'-substituted adenosines with that of 2'-deoxyadenosine ( $\Delta\delta$ ) was plotted against  $\chi$  value (Fig. 3), we could observe a linear relationship between them.



We then analyzed crystals of 2'-fluoroadenosine, -inosine and -guanosine by X-ray crystallography. As shown in Fig. 4, 2'-fluorinosine crystallized in two forms having *anti* and *syn* conformations, but angles between  $\text{H}_1$  and  $\text{H}_2$  are both around  $90^\circ$ , which is just suggested by NMR measurements. Accordingly, conformation of the carbohydrate moiety stays at 3'-endo (N) conformation. 2'-Fluoro-2'-deoxyadenosine crystallized in almost the same conformation with one fluorinosine crystal, showing the 3'-endo form. The guanosine derivative showed very complex features in eight forms, but all forms again showed N-conformations. Therefore, 2'-fluoro substitution always determined the conformation in 3'-endo (N) form. The cause of this phenomenon was explained by Guschlbauer<sup>12</sup> as dipolar interaction of the C-F bond and the furanose ring. However, another interpretation by Olson has been presented.<sup>14</sup>

As deduced from these results, 2'-substituents exerted a great effect on the conformation of nucleosides. If we assume H or OH substitution at the 2'-carbon of the furanose ring as in 2'-deoxy or ribonucleosides, the electronegativity of these substituents may be the governing factor determining the structure of nucleosides, which are components of DNA and RNA, and may determine the conformation of nucleic acids.

Fig. 4

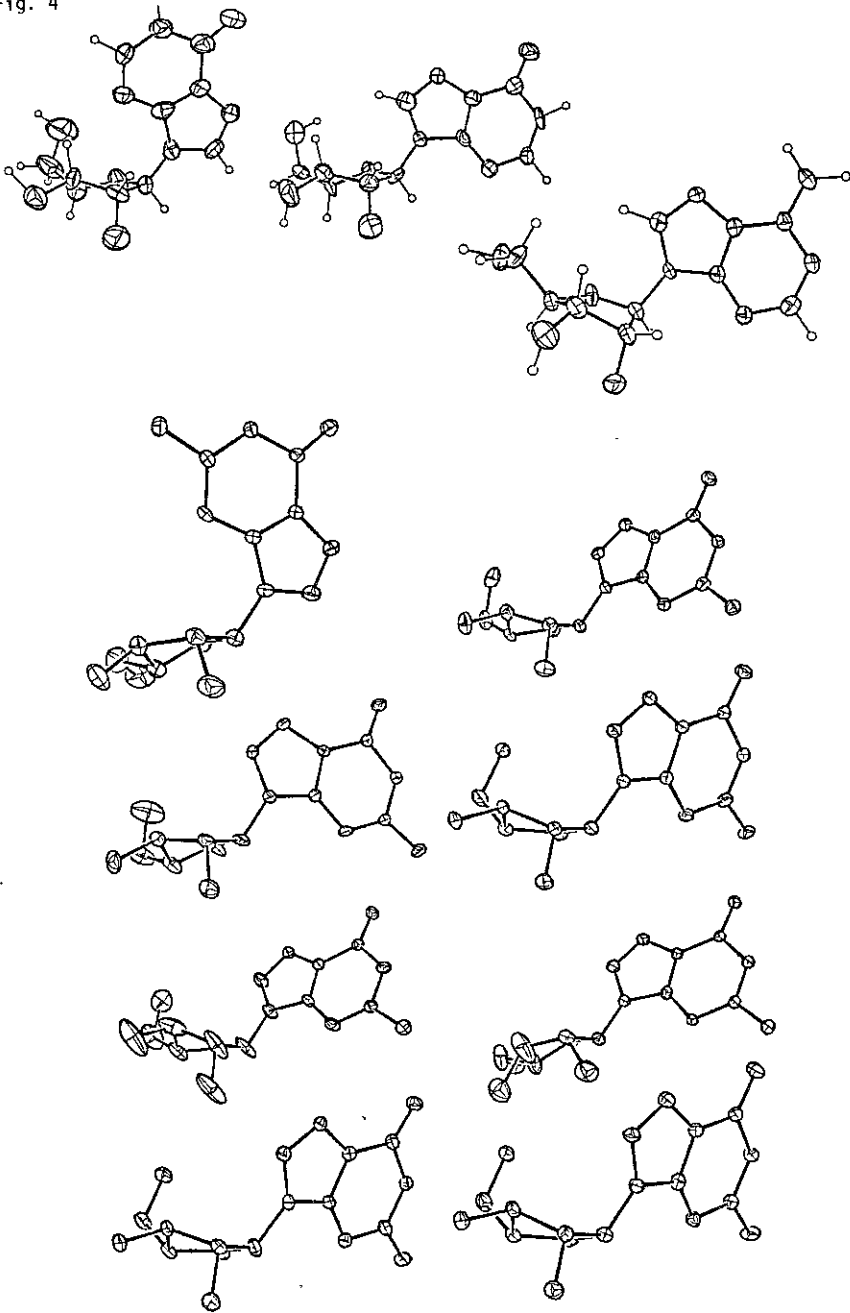

We then synthesized some phosphate esters of 2'-substituted purinenucleosides. First 3',5'-cyclic phosphate of 2'-fluoro-2'-deoxyadenosine (dAfl) was synthesized as in Chart 2.<sup>15</sup>

Chart 2

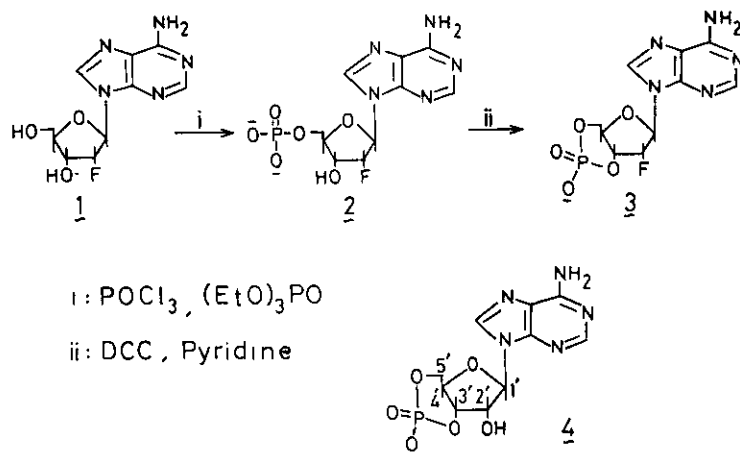

The structure of this compound was confirmed by physical measurements. We found previously that assignment of  $^{13}\text{C}$  signal of  $\text{C}_3$ , and  $\text{C}_4$ , in 3',5'-cyclic AMP has to be exchanged. This alteration was confirmed by investigation of  $^{13}\text{C}$  NMR of 3',5'-cyclic dAflMP, because of the unambiguous coupling of  $^{13}\text{C}$ - $^{19}\text{F}$ .

Investigation of the biochemical properties of the monomers, dAfl and 2'-azido-2'-deoxyadenosine were studied together with arabinosyl derivatives. When these nucleosides are treated with human erythrocyte adenosine deaminase,<sup>16</sup> fluoro derivatives showed low  $K_m$  values and deaminated rapidly as in the case of adenosine. However, azido derivatives are not deaminated efficiently and may be used as a deaminase inhibitor. When these analogs were incubated with purine nucleoside phosphorylase (PNP), dAfl showed either the substrate or inhibitor activity in rather unfavorable kinetics. This may be caused by conformational difference of this compound with natural nucleosides. Incubation of these nucleosides with sarcoma 180, lymphocytes and erythrocytes gave 5'-di- and triphosphates, respectively.

dAflTP and dAzTP were tested as substrates of DNA-dependent RNA polymerase of *E. coli*.<sup>17</sup> In the presence of UTP, dAzTP was incorporated as 10 % of ATP and thus acted as a competitive inhibitor. On the other hand, dAflATP copolymerized with UTP only 1 % of ATP and exerted a strong inhibitory effect to poly(AU) synthesis. We therefore deduced that the conformation of dAzATP is rather like ATP and that of dAflTP may be very different from ATP. dAflTP may be useful as an inhibitor of RNA polymerization. A recent study of Seno et al.<sup>18</sup> showed that DNA polymerase  $\alpha_1$  of Ehrlich ascites tumor cells, which is known to polymerise RNA on poly-(dT), was strongly inhibited by the

presence of dAzTP. This result also suggested a very similar conformation of dAzTP with ATP, but it did not act as a substrate of RNA polymerase. When dAf1ATP was incubated with DNA polymerase (Klenow fragment) in the presence of Poly(dA-dT) or calf thymus DNA, 3-4 % or 20 % of pdAf units were incorporated.<sup>19</sup> This fact may suggest that dAfTP had a different affinity to this enzyme, because of the unusual 3'-endo conformation not present in dATP. Thus far, the conformation of the mother nucleoside will be retained in 5'-phosphates and used as weak substrates in some cases and as inhibitors in other cases. Utilization of these nucleotides in biological systems might be conducted in the future.

We next synthesized a variety of oligonucleotides starting from 2'-substituted 2'-deoxynucleosides with the aim of investigating the relationship of monomer and oligomer conformation.<sup>20</sup> First, we synthesized adenosine dimers containing dAz, dAf1, dAc1, dAbr, and dAio with 2'-deoxyadenosine or adenosine. The synthetic pathway for these dimers is illustrated in Chart 3. Either 5'- or 3'-OH are phosphorylated and condensed to another part having protection on the 3' or 5'-OH group.

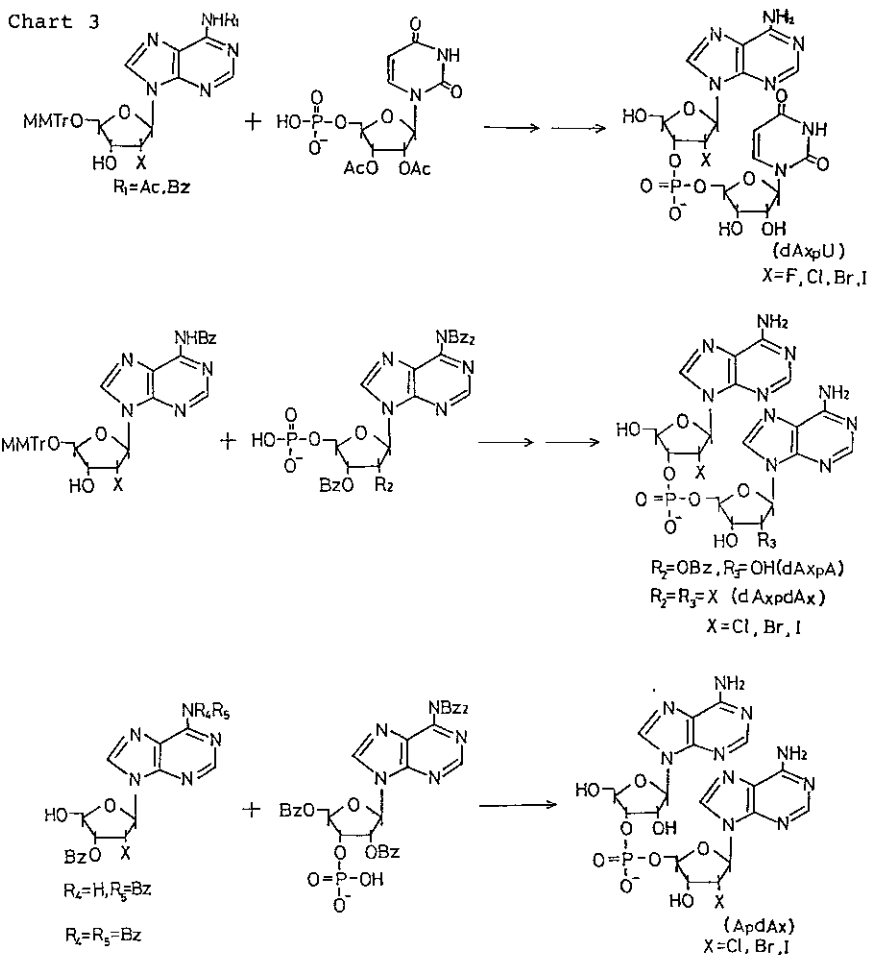



Dimers were purified by column chromatography and analyzed by enzymatic degradation to give component monomers.

We first compared CD spectra of ApdAfI, dAfI<sub>p</sub>A, dAfI<sub>p</sub>dAfI and ApA. These analogs showed a pattern (Fig. 4) similar to that of ApA, suggesting that they have right-handed stacking conformation established in ApA.<sup>21</sup> However, the magnitude of CD bands is in the order, dAfI<sub>p</sub>dAfI > dAfI<sub>p</sub>A > ApdAfI > ApA. This means that the conformation of the fluorine-containing nucleotide enhanced stacking mainly by a 3'-endo conformation as clarified earlier. This point was further confirmed by the

Fig. 5

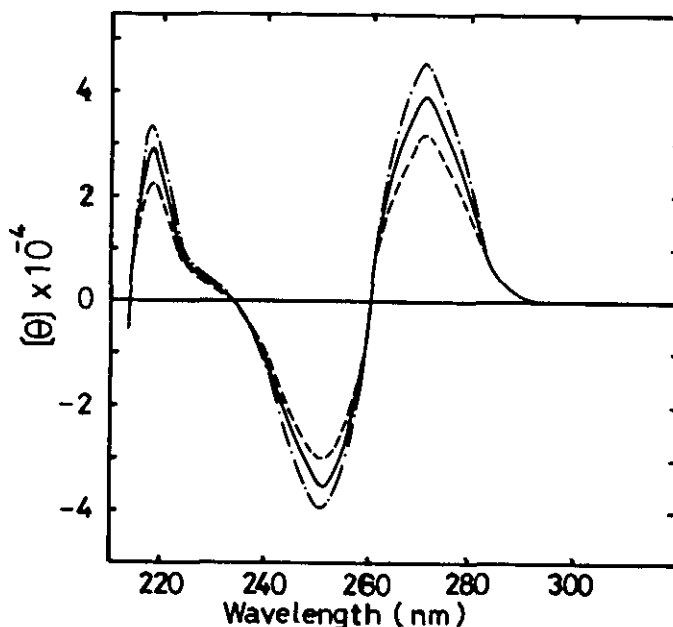

hybridization of these ApA analogs with poly(U) forming three-stranded helical complexes. The  $T_m$ 's of these complexes are also in the order of dAfI<sub>p</sub>dAfI > dAfI<sub>p</sub>A > ApdAfI.

Multinuclear NMR studies of these dimers were carried out in order to examine the detailed structure<sup>22</sup> (Table III). All  $^1\text{H}$ ,  $^{19}\text{F}$  and  $^{31}\text{P}$  signals were definitively assigned and the following results obtained: 1) 3'-endo conformation of dAf residues is greatly enhanced by taking a stacked conformation, 2) dimerization shift is in the order of dAfI<sub>p</sub>dAfI > dAfI<sub>p</sub>A > ApdAfI > ApA, 3)  $^{19}\text{F}$  atoms in the oligomer strands might be a useful signal of the conformational studies. These properties were essentially the same with dAcI- or dAz-containing dimers, but these dimers showed very similar conformations with that of ApA, because of the same degree of C<sub>3'</sub>-endo populations in the monomer units. Therefore, it might be concluded that for stabilization of a ribodimer like ApA, the 2'-OH group acts as a polar sterical group and not as a hydrogen bond donor or acceptor.

We then synthesized heterodimers containing U or C units together with dAx or dGx. In the case of dAxpU series, the degree of stacking as determined by UV hypochromicity, CD and  $^1\text{H}$  NMR was in the order: dAflpU>dAclpU>dAbrpU>dAiopU. Therefore, it was concluded that for stacking conformation, the 2'-substituents exerted effects by their inductive electronegativity and sterical bulkiness. As a non-hydrolyzable substrate of RNase T1, which cleaved only at Gp residues in RNA, dGflpU was synthesized by a method essentially analogous to that described earlier. As studies by UV, CD and NMR, this dimer has rather weakly stacked conformation and may be useful for crystallization with RNase T1 for X-ray studies.

Table III Population distribution of conformers in dinucleoside monophosphates containing 2'-fluoro-2'-deoxyadenosine and their components<sup>a</sup>

Compounds	Temp °C	Sugar ring		Back bone	
		Z <sup>3</sup> E	% gg	% g'g'	φ
2'-fl-2'-dA	25	76	82	-	-
	75	71	73	-	-
2'-fl-2'-dA-3'-p	25	72(31) <sup>b</sup> (23) <sup>c</sup>	81(82) <sup>b</sup> (71) <sup>c</sup>	-	206 <sup>o</sup> /274 <sup>o</sup> (204 <sup>o</sup> /276 <sup>o</sup> ) <sup>b</sup> (202 <sup>o</sup> /278 <sup>o</sup> )
	75	67	67	-	206 <sup>o</sup> /274 <sup>o</sup>
2'-fl-2'-dA-5'-p	25	76(40) <sup>b</sup> (28) <sup>c</sup>	88(77) <sup>b</sup> (63) <sup>c</sup>	75(72) <sup>b</sup> (70) <sup>c</sup>	-
	75	72	73	65	-
dAflpA, dAflp-	25	88(58) <sup>d</sup> (22) <sup>e</sup>	81(79) <sup>d</sup> (73) <sup>e</sup>	-	206 <sup>o</sup> /274 <sup>o</sup> (203 <sup>o</sup> /277 <sup>o</sup> ) <sup>d</sup> (195 <sup>o</sup> /285 <sup>o</sup> ) <sup>e</sup>
		-pA	60(61) <sup>d</sup> (37) <sup>e</sup>	87(74) <sup>d</sup> (87) <sup>e</sup>	89(90) <sup>d</sup> (85) <sup>e</sup>
dAflp-	75	-pA	79	76	204 <sup>o</sup> /276 <sup>o</sup>
		-pA	53	79	78
ApdAfl, Ap-	25	-pA	63	82	204 <sup>o</sup> /276 <sup>o</sup>
		-pA	84	90	84
Ap-	75	-pA	60	71	202 <sup>o</sup> /278 <sup>o</sup>
		-pA	80	67	77
dAflpdAfl, dAflp-	25	-pA	87	85	204 <sup>o</sup> /276 <sup>o</sup>
		-pA	86	95	95
dAflp-	75	-pA	78	70	204 <sup>o</sup> /276 <sup>o</sup>
		-pA	82	82	79

As we have synthesized a variety of oligonucleotides for the construction of the tRNA molecule,<sup>23</sup> enzyme recognition sites,<sup>24</sup> and genes for peptides and hormones,<sup>25</sup> oligonucleotides containing the 2'-substituted 2'-deoxynucleotides might be interesting for elucidation of the structure-function relationship of these nucleic acids.

It was known that the tRNA molecule has a common CCA 3'-terminal, which accepts amino acid according to codes on messenger RNA. In order to incorporate odd bases at this terminal position by using Ligase RNA, we synthesized tetramers containing dAz and dAf, ACCAx.<sup>26</sup> Using ACC trimers as the acceptor, pyrophosphate AppAx was reacted in the presence of RNA ligase. These tetramers were further joined with the tRNA molecule lacking 3'-end tetranucleotide to obtain fully reconstructed tRNA molecules.:

- 1) ApCpC + AppAx ---- ApCpCpAx
- 2) tRNA(-4nt) + ApCpCpAx ---- tRNA-CCAx

The anticodon position containing A residue is now under replacement with dAx. Using these fluorine-containing tRNA, several studies for investigating tRNA structure are expected. We further synthesized self complementary octanucleotides with the sequence recognized by a restriction enzyme EcoRI.<sup>27</sup> Several studies indicated that the base moiety of the constituent nucleotide is important for its recognition by the enzyme, but studies dealing with the carbohydrate moiety of recognition sequences are few. The synthesis of the octamer is illustrated in Chart 4. The method is essentially as reported earlier<sup>24</sup> and the octamers were obtained in quantity. An octamer containing dGfl at second position was obtained analogously. When these octamers were incubated with EcoRI, digestion proceeded as illustrated in Fig. 6. Surprisingly, the octamer

Chart 4

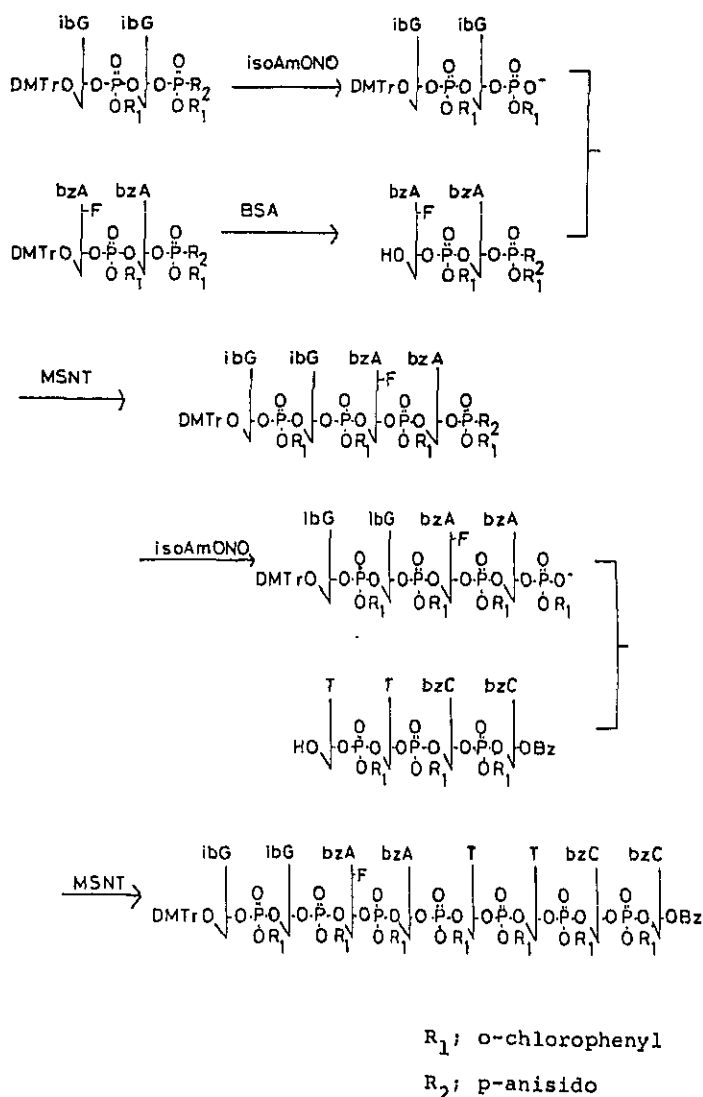
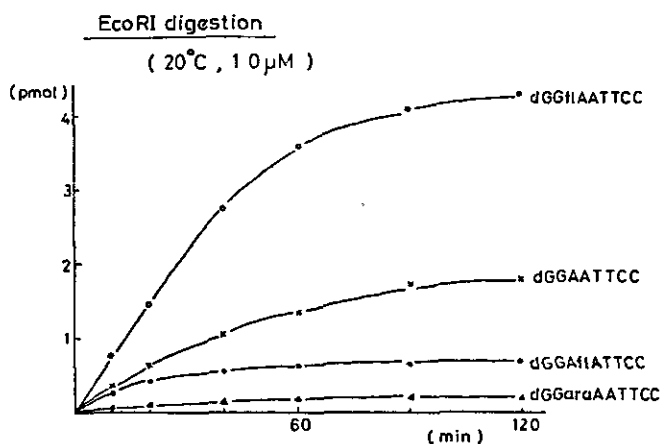

Fig. 6



containing dGfl was split most easily, more than twice as much as natural dGGAATTC. Another octamer containing dAf at the third position was digested as less than half the parent octamer. NMR studies of these octamers showed that the dAf unit in the third position had  $J_{1,2} = 5.2$ , suggesting 40 % N-conformer in this double helical octamer. Therefore, total conformation of this octamer will be just as in natural DNA, and the fluorine atom in this octamer distorted the enzyme recognizing site(s). The cause of enhancement by dGfl at the second position may be changing the conformation of this octamer to a favorable one.

As it could be safely predicted that oligonucleotides containing dAx or dGx should have conformation like RNA rather than DNA, polynucleotides consisting these nucleotides might have physicochemical and biochemical properties as RNA. Thus, we prepared a variety of polynucleotides, poly(dAf), poly(dAcI), poly(dAbr), poly(dAn), poly(dIz), poly(dIfI) and poly(dIcI) by using polynucleotide phosphorylase and appropriate diphosphates.<sup>28</sup> Physico-chemical studies showed that poly(dAx) most resembled poly(rA). For instance, poly(dAf) has  $\epsilon$  value(per residue) of 9,700, and the hypochromicity around 295 nm was 32 % as tabulated in Table IV. The UV absorption maxima shifted bathochromically 2-3 nm from that of the monomers. Hypochromicity calculated from monomer absorption was around 30 % for poly(dAx) and 20 % for poly(dIX). The CD spectra of these polynucleotides are similar to those of poly(rA), as shown in Fig. 7. The total profile of the curve is very similar to that of poly(rA), suggesting a similar conformation with poly(rA). Polymers poly(dAx) formed double and triple stranded-complexes with poly(rU) and a three stranded complex with poly(rI)

Table IV

Compound	$\epsilon$	$\lambda_{\max}$ (nm)	hypochromicity (%)
poly(rA)	10,000	257	35
poly(dAf)	9,700	255	32
poly(dAc1)	10,500	257	32
poly(dAbr)	10,700	257	29
poly(dAa)	11,200	258	25
poly(dIf1)	9,800	245 (sh 273)	20
poly(dIc1)	10,300	248	20
poly(dIz)	10,950	247	11

Fig. 7

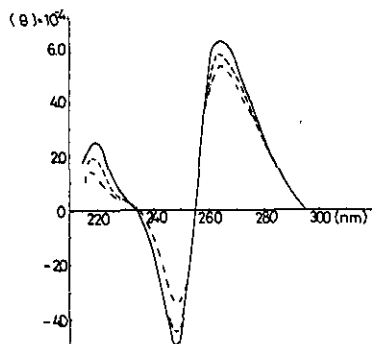

CD spectra of poly(Af), poly(Ac1) and poly(Abr). Poly(Af) —, poly(Ac1) ---, poly(Abr) -.-.-.

Fig. 8

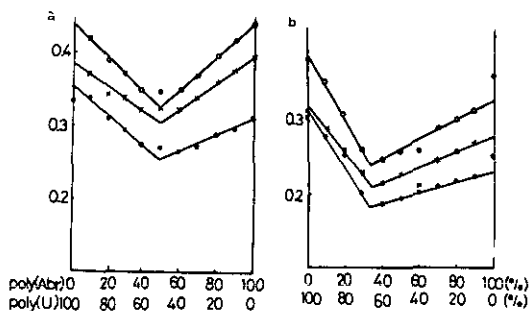

Complex Formation of Poly (Abr) with Poly (U).

as their parent poly(rA) (Fig. 8).  $T_m$ 's of these complexes are 53 - 64° in the presence of a 0.15M  $\text{Na}^+$  ion showing a comparable value with poly(rA) (62°). These results clearly showed that polynucleotides consisting of dAx residues had physical properties very similar to those of poly(rA). Poly(dIx) also showed properties very similar to those of poly(rI).

We investigated the biological properties of these polynucleotides against RNA-dependent DNA polymerase<sup>29</sup> (reverse transcriptase), *in vitro* protein synthetic system<sup>30</sup> and interferon induction.<sup>31</sup> When poly(dAf1), poly(dAz) and poly(dIf1) were treated with reverse transcriptase from murine leukaemia virus, fluorine containing polymers served as a good template for DNA synthesis. In contrast to this, poly(dAz) strongly inhibited the activity of the enzyme. This fact again suggested that also in these incubation conditions the polymers are in favorable conformation and they are well present in the incubation systems because of structure less degradable than usual RNA templates. When poly(dAf1), poly(dAc1) and poly(dAbr) were used as the messenger for protein synthesis, these polymers acted as a good messenger for poly(Lys) synthesis. Poly(dAf1) was an especially good messenger compared to poly(rA). This fact may suggest that protein synthesis requires RNA of rather well stacked form, and the duration of this polynucleotide against RNase will be a favorable factor for protein synthesis.

Interferon induction by poly(rI)·poly(rC) double-stranded polynucleotides is well known. A variety of polynucleotides were studied in searching for a new and effective inducer. In this connection a rule was presented that for the induction of interferon a polynucleotide double strand having 2'-OH groups in both strands must be necessary. However, we found that poly(dIf), poly(dIcI) and poly(dIz) are very strong inducers in various interferon-inducing systems. As shown in Table V, poly(dIfI)·poly(rC) was found to be the most active compound exceeding that of parent poly(rI)·poly(rC). These results again suggested that poly(dIfI)·poly(rC) may be present in the reaction systems in just such a conformation of poly(rI)·poly(rC) and that the interferon-inducing system does not require any OH groups in at least one strand of RNA. Instead, they recognized total polynucleotide conformation for effective induction of interferon. In order to have a definite proof for the structure of poly(dIf)·poly(rC) in solution, we examined the fiber X-ray pattern of this compound.<sup>32</sup> As shown in Fig. 9, the total conformation was very similar to the poly(rI)·poly(rC) structure, but the poly(dIfI) strand has a somewhat different conformation in the carbohydrate moiety, 4'-exo form, which is the alternative 3'-endo. In addition to this, the chemical structure resistant to RNases may be helpful for strong activity. We concluded, therefore, that the function of RNA might be determined by its three dimensional conformation, which was derived from its chemical structure.

Table V *Interferon-inducing activity of (I)<sub>n</sub>·(C)<sub>n</sub>, (dIf)<sub>n</sub>·(C)<sub>n</sub> and (dIcI)<sub>n</sub>·(C)<sub>n</sub> in various cell culture systems*

System	Polynucleotide	log <sub>10</sub> Interferon titer/units ml <sup>-1</sup> at a polynucleotide concentration of				
		0.001 µg/ml	0.01 µg/ml	0.1 µg/ml	1 µg/ml	10 µg/ml
Primary rabbit kidney cells 'superinduced' with cycloheximide and actinomycin D	(I) <sub>n</sub> ·(C) <sub>n</sub>	< 1.0	1.5	2.5	3.6	4.1
	(dIf) <sub>n</sub> ·(C) <sub>n</sub>	1.5	3.7	3.8	4.1	4.4
	(dIcI) <sub>n</sub> ·(C) <sub>n</sub>	1.2	3.4	4.0	4.5	4.5
Human skin fibroblast cells 'superinduced' with cycloheximide and actinomycin D	(I) <sub>n</sub> ·(C) <sub>n</sub>	< 1.0	2.5	3.7	4.0	4.0
	(dIf) <sub>n</sub> ·(C) <sub>n</sub>	< 1.0	2.2	4.0	4.2	4.3
	(dIcI) <sub>n</sub> ·(C) <sub>n</sub>	< 1.0	1.8	3.5	3.9	4.0
Mouse L-929 cells 'primed' with interferon	(I) <sub>n</sub> ·(C) <sub>n</sub>	< 0.5	< 0.5	1.2	1.6	1.8
	(dIf) <sub>n</sub> ·(C) <sub>n</sub>	< 0.5	< 0.5	1.2	1.7	2.0
	(dIcI) <sub>n</sub> ·(C) <sub>n</sub>	< 0.5	< 0.5	1.3	1.5	1.8
Mouse L-929 cells pretreated with DEAE-dextran	(I) <sub>n</sub> ·(C) <sub>n</sub>	< 0.5	< 0.5	1.6	3.4	3.4
	(dIf) <sub>n</sub> ·(C) <sub>n</sub>	< 0.5	< 0.5	< 0.5	< 0.5	< 0.5
	(dIcI) <sub>n</sub> ·(C) <sub>n</sub>	< 0.5	< 0.5	< 0.5	< 0.5	< 0.5
Vero cells 'superinduced' with cycloheximide and actinomycin D	(I) <sub>n</sub> ·(C) <sub>n</sub>	—	—	< 1.0	< 1.0	< 1.0
	(dIf) <sub>n</sub> ·(C) <sub>n</sub>	—	—	< 1.0	< 1.0	< 1.0
	(dIcI) <sub>n</sub> ·(C) <sub>n</sub>	—	—	< 1.0	< 1.0	< 1.0
HeLa cells 'superinduced' with cycloheximide and actinomycin D	(I) <sub>n</sub> ·(C) <sub>n</sub>	—	1.2	1.7	2.2	2.0
	(dIf) <sub>n</sub> ·(C) <sub>n</sub>	—	1.7	2.0	2.5	2.3
	(dIcI) <sub>n</sub> ·(C) <sub>n</sub>	—	1.5	1.5	2.2	2.7

Fig. 9

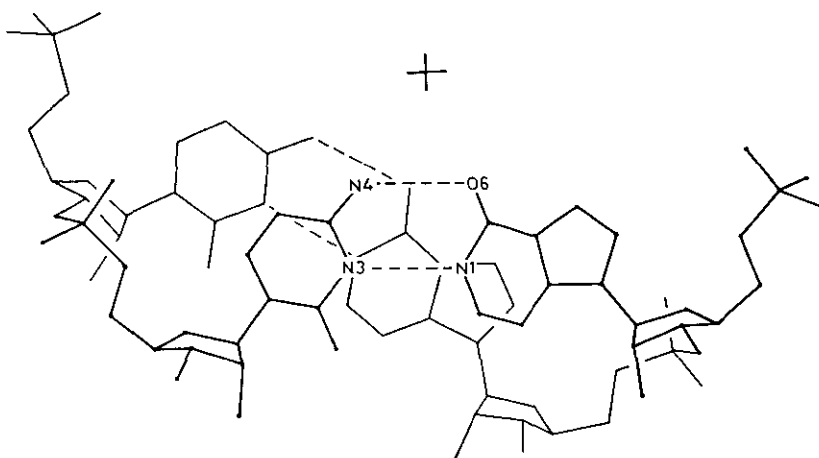

## REFERENCES

- 1) M. Ikehara, T. Maruyama and H. Miki, *Tetrahedron*, **34**, 1133-1138 (1978); M. Ikehara and H. Miki, *Chem. Pharm. Bull.*, **26**, 2449-2453 (1978); M. Ikehara and T. Maruyama, *ibid.*, **26**, 240-244 (1978).
- 2) M. Ikehara, *Accounts Chem. Res.*, **2**, 47-53 (1969); M. Ikehara and T. Maruyama, *Tetrahedron*, **31**, 1369-1372 (1975).
- 3) M. Ikehara and A. Hasegawa, *J. Carbohyd. Nucleosid. Nucleotid.*, **7**, 131-140 (1980).
- 4) M. Ikehara, T. Maruyama and H. Miki, *Tetrahed. Lett.*, 4485-4488 (1976); M. Ikehara and J. Imura, *Chem. Pharm. Bull.*, **29**, 1034-1038 (1981); *idem*, *ibid.*, **29**, 3281-3285 (1981).
- 5) T. Nakanishi, F. Tomita and T. Suzuki, *Agr. Biol. Chem.*, **38**, 2465-2469 (1974); *idem*, *ibid.*, **41**, 287-291 (1977).
- 6) N. Ohkawa, H. Nakayama, K. Ikeda, K. Furihata, A. Shimazu, N. Ohtake and H. Yonehara, *Agr. Biol. Chem.*, **44**, 1671-1672 (1980).
- 7) H. Morisawa, T. Utagawa, T. Nakamatsu, S. Yamanaka and Y. Yamazaki, *Nucleic Acids Res., Symp. Ser.*, **8**, 11-14 (1980); J. B. Hobbs and F. Eckstein, *J. Org. Chem.*, **42**, 714-719 (1977).
- 8) R. Ranganathan, *Tetrahed. Lett.*, 1291-1294 (1977).
- 9) M. L. Wolfrom and M. W. Wikley, *J. Org. Chem.*, **32**, 1823-1825 (1967).
- 10) S. Uesugi, H. Miki, M. Ikehara, H. Iwahashi and M. Kyogoku, *Tetrahed. Lett.*, 4073-4076 (1976).
- 11) C. Altona and M. Sundaralingam, *J. Am. Chem. Soc.*, **95**, 2333-2334 (1973).
- 12) W. Gushibauer and K. Jankowski, *Nucleic Acids Res.*, **8**, 1421-1433 (1980).
- 13) S. Uesugi, H. Miki and M. Ikehara, *Chem. Pharm. Bull.*, **29**, 2199-2240 (1981).
- 14) W. K. Olson and J. L. Sussman, *J. Am. Chem. Soc.*, **104**, 270-286 (1982).
- 15) S. Uesugi, J. Matsugi, T. Kaneyasu and M. Ikehara, *Heterocycles*, **17**, 283-288 (1982).
- 16) J. D. Stoeckler, C. A. Bell, R. E. Parks Jr., C. K. Chu, J. J. Fox and M. Ikehara, *Biochem. Pharmacol.*, **31**, 1723-1728 (1982).
- 17) A. Ishihama, M. Enami, Y. Nishijima, T. Fukui, E. Ohtsuka and M. Ikehara, *J. Biochem.*, **87**, 825-830 (1980).

- 18) T. Yagura, T. Kozu, T. Seno, Y. Nishijima, E. Ohtsuka and M. Ikehara, *Biochem. Biophys. Res. Commun.*, 104, 1189-1195 (1982).
- 19) Unpublished experiments by T. Fukui.
- 20) S. Uesugi, Y. Takatsuka and M. Ikehara, *Chem. Pharm. Bull.*, 27, 1830-1835 (1979); S. Uesugi, Y. Takatsuka, M. Ikehara, D. M. Cheng, L. S. Kan and P. O. P. Ts'o, *Biochemistry*, 20, 3056-3062 (1981); S. Uesugi, Y. Takatsuka, A. Ohta and M. Ikehara, *Nippon Kagakukaishi*, 1981, 851-859; S. Uesugi, T. Kaneyasu and M. Ikehara, *Biochemistry*, 21, 5870-5877 (1980); M. Ikehara and J. Imura, *Chem. Pharm. Bull.*, 29, 2408-2412 (1981).
- 21) N. S. Kondo, H. M. Holmes, L. M. Stempel and P. O. P. Ts'o, *Biochemistry*, 9, 3479-3498 (1970).
- 22) D. M. Cheng, L. S. Kan, P. O. P. Ts'o, S. Uesugi, Y. Takatsuka and M. Ikehara, *Biopolymers*, 22, 1427-1444 (1983); S. Uesugi, T. Kaneyasu, J. Imura, M. Ikehara, D. M. Cheng, L. S. Kan and P. O. P. Ts'o. *Biopolymers*, 22, 1189-1202 (1983).
- 23) E. Ohtsuka, S. Tanaka, T. Tanaka, T. Miyake, A. F. Markham, E. Nakagawa, T. Wakabayashi, Y. Taniyama, S. Nishikawa, R. Fukumoto, H. Uemura, T. Doi, T. Tokunaga and M. Ikehara, *Proc. Nat. Acad. Sci. USA*, 78, 5493-5497 (1981).
- 24) E. Ohtsuka, T. Ono and M. Ikehara, *Chem. Bull. Bull.*, 29, 3274-3280 (1981); E. Ohtsuka, S. Shibahara and M. Ikehara, *ibid.*, 30, 1307-1314 (1982); E. Ohtsuka, E. Morisawa and M. Ikehara, *ibid.*, 30, 874-880 (1982).
- 25) E. Ohtsuka, Y. Taniyama, R. Marumoto, H. Sato, H. Hirosaki and M. Ikehara, *Nucleic Acids Res.*, 10, 2597-2608 (1982).
- 26) E. Ohtsuka, T. Miyake, K. Nagano, H. Uemura, S. Nishikawa and M. Ikehara, *Nucleic Acids Res.*, 8, 601-610 (1980).
- 27) Unpublished results by H. Ibaraki.
- 28) M. Ikehara, T. Fukui and N. Kakiuchi, *Nucleic Acids Res.*, 4, 989-1000 (1977); T. Fukui, N. Kakiuchi and M. Ikehara, *ibid.*, 4, 2629-2639 (1977); M. Ikehara, T. Fukui and N. Kakiuchi, *ibid.*, 4, 4249-4260 (1977); *idem*, *ibid.*, 5, 1877-1887 (1978); M. Ikehara, N. Kakiuchi, and T. Fukui, *ibid.*, 5, 3315-3324 (1978); N. Kakiuchi and M. Ikehara, *ibid.*, 6, 2627-2636 (1979).
- 29) E. DeClercq, T. Fukui, N. Kakiuchi, M. Ikehara, M. Hattori and W. Pflleiderer, *Cancer Res.*, 7, 27-37 (1979); T. Fukui, E. DeClercq, N. Kakiuchi and M. Ikehara, *ibid.*, 16, 129-135 (1982).
- 30) T. Fukui, N. Kakiuchi and M. Ikehara, *Biochim. Biophys. Acta*, 697, 174-177 (1982).
- 31) E. DeClercq, T. Fukui, N. Kakiuchi and M. Ikehara, *J. Pharm. Dyn.*, 1, 62-65 (1978); E. DeClercq, B. D. Stoller, J. Hobbs, T. Fukui, N. Kakiuchi and M. Ikehara, *Europ. J. Biochem.*, 107, 279-288 (1980).
- 32) T. Hakoijima, Dissertation for Ph. D. of Osaka University.