

RECENT ADVANCES IN STEREOCHEMICAL CONTROL: MULTIPLE ASYMMETRIC INDUCTION

Satoru Masamune

Department of Chemistry, Massachusetts Institute of Technology,  
Cambridge, Massachusetts 02139, U.S.A.

Abstract — A new synthetic strategy based on the concept of multiple asymmetric induction is capable of constructing any new chiral center or centers on a chiral substrate as demonstrated in three major organic reactions: the aldol reaction, the Diels-Alder reaction, and epoxidation of allylic alcohols.

Several natural product syntheses serve to illustrate the degree of stereoselection that has now been achieved.

1. Introduction

For many years our major research efforts have been directed toward the synthesis of several macrolide antibiotics, a group of compounds which may be exemplified by erythromycin A (1), amphotericin B (2), and rifamycin S (3).<sup>\*1</sup> Distinct in their

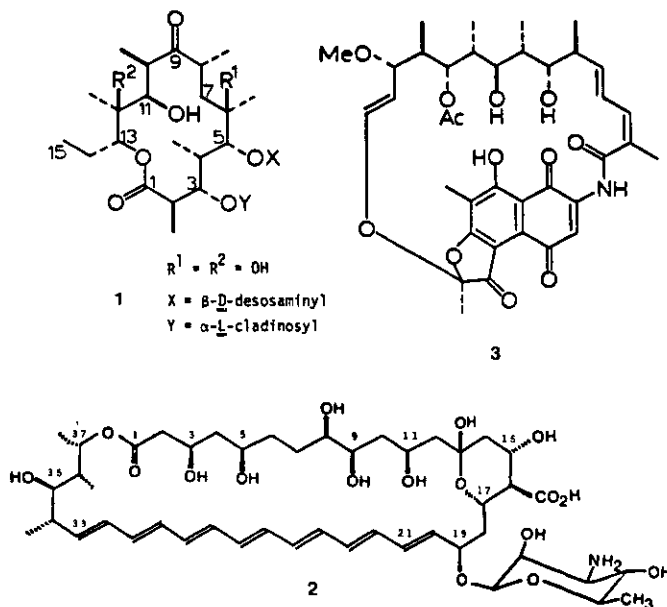

\* The word "macrolide" is used in a broad sense and includes macrolactams, for example the ansamycins such as rifamycin S.

structural features, these compounds revealed, even at the outset of this project, the existence of three major unsolved problems associated with macrolide synthesis: macro-lactonization, glycosidation, and stereochemical control.<sup>2</sup> This last problem concerns the proper assembly of numerous chiral centers embedded in the large lactonic and lactamic systems, and demands a conceptually new approach for its solution. In this lecture I will first discuss the stereochemical outcome of organic reactions involving a set of two reactants (substrate and reagent), each of which is either achiral or chiral. The analysis of these reaction courses will lead to a new strategy which is potentially applicable to the construction of any new chiral center or centers on a chiral substrate in a predictable manner. This process is fundamentally important and frequently encountered in natural products synthesis. It will become clear that the strategy demands the development of enantiomerically pure (homochiral) reagents that must meet a new set of criteria (see below). Such reagents have indeed been prepared to effect three major organic reactions with high stereoselection: the aldol reaction, the Diels-Alder reaction, and epoxidation.\* The lecture will also include the use of these reagents in the total synthesis of several natural products of medium complexity, which serves to demonstrate the degree of stereocontrol that has now been achieved.

## 2. Multiple Asymmetric Induction<sup>3</sup>

Let us consider at first a general case where a chiral substrate ( $S_n-I$ ) having an  $sp^2$  carbon reacts with an achiral reagent to give products  $P_a$  and  $P_b$  (Scheme 1). Because  $S_n-I$  is chiral, one of the two diastereomeric transition (si-attack or re-attack)\*\* will be lower in energy than the other. This results in one product being produced to a greater extent, and thus the  $P_a/P_b$  is not unity. This ratio  $P_a/P_b$  is referred to as the diastereofacial selectivity (D.S.) of  $S_n-I$ . For instance, reduction of norcamphor (**4**) with lithium aluminum hydride provides a mixture of endo- and exo-norborneols (**5** and **6**), the D.S. being 89:11.<sup>4</sup> This example, although very

\* This refers to Sharpless' epoxidation, as will be discussed in the lecture.

\*\* Assuming that Cahn-Ingold-Prelog priority of  $R^1$  (or  $R^{1*}$ ) is higher than that of  $R$ , the si and re faces of  $S_n-I$  are those designated in Schemes 1-3.

Scheme 1



Pa/Pb (diastereofacial selectivity of S-I)  $\neq$  1

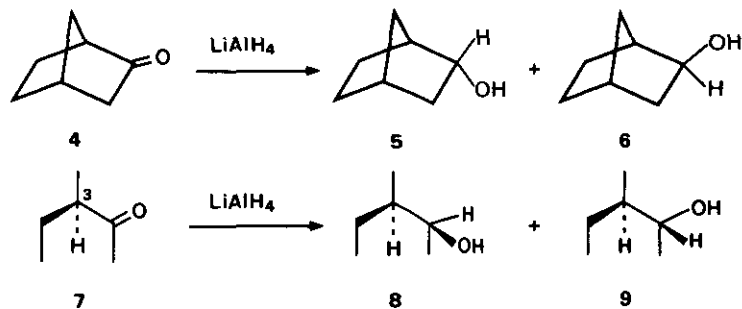

simple, illustrates a principle that has guided synthetic organic chemists in designing the structure of a substrate, starting material or intermediate, in order to incorporate proper stereochemistry in the reaction product. A variety of complex natural products with many chiral centers have almost invariably been synthesized in this way.

In contrast to the cyclic system exemplified above by **4**, a high diastereofacial selectivity, significant enough to be synthetically useful, is normally difficult to attain with acyclic systems. For instance, hydride reduction of 3-methylpentan-2-one (**7**) will, in all likelihood, proceed non-stereoselectively, because the acyclic ketone **7** is conformationally flexible and the difference in both steric and stereoelectronic effect exerted by the methyl and ethyl groups attached to the C-3 carbon of **7** is insignificant. Two products **8** and **9** will result in nearly equal quantities. This non-stereoselectivity led us to search for a new means of stereocontrol other than structural modification of the substrate. Thus we sought methodology capable of not only producing either **8** or **9** predominantly from **7**, but also of reversing the "normal" stereochemical course of reduction of **7** if so chosen.

Let us consider another general case where an achiral substrate ( $A-I$ ) reacts with a chiral reagent, e.g., a chiral enolate ( $S-II$ ), to give rise to products  $P'_a$  and  $P'_b$  (Scheme 2). In an analogous manner to that mentioned for Scheme 1 ( $S-II$  is chiral in Scheme 2) two diastereomeric transition states that emerge from the si- and re-attack will differ in energy, resulting in the ratio  $P'_a/P'_b$  not being unity. This ratio is referred to as the diastereofacial selectivity of  $S-II$ . For instance, it can be easily predicted that the chiral enolate  $10$ , if prepared, would react with aldehyde  $11$  preferentially from one side of  $11$ .

Scheme 2

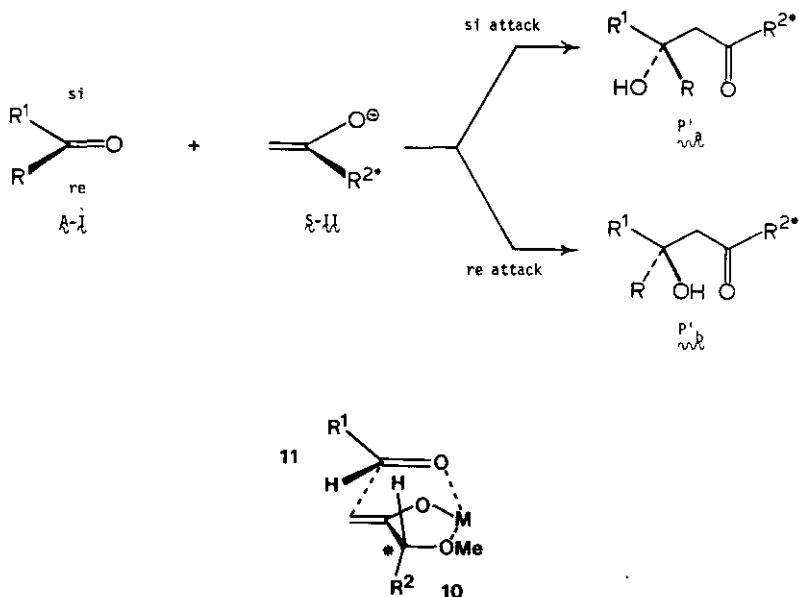

$P'_a/P'_b \neq 1$   
 " = diastereofacial selectivity of  $S-II$

When (reagent)  $S-II$  is homochiral, the outcome of the stereochemical consequence of the reaction between  $A-I$  and  $S-II$  constitutes the basis of (single) asymmetric synthesis as originally defined by W. Marckwald.\*

\* (Ber. 1904, 37, 1368): "Those reactions which produce optically active substances from symmetrically constituted compounds with the intermediate use of optically active materials but with the exclusion of all analytical processes."

Now consider the case where a chiral substrate ( $S-I$ ) reacts with chiral reagent ( $S-II$ ) to afford products  $R''_a$  and  $R''_b$  (Scheme 3), with the assumption that both  $S-I$  and  $S-II$  favor the si-attack transition state (i.e.,  $R_a/R_b > 1$  and  $R'_a/R'_b > 1$ , respectively). This process is characterized by multiple (double) asymmetric induction

Scheme 3

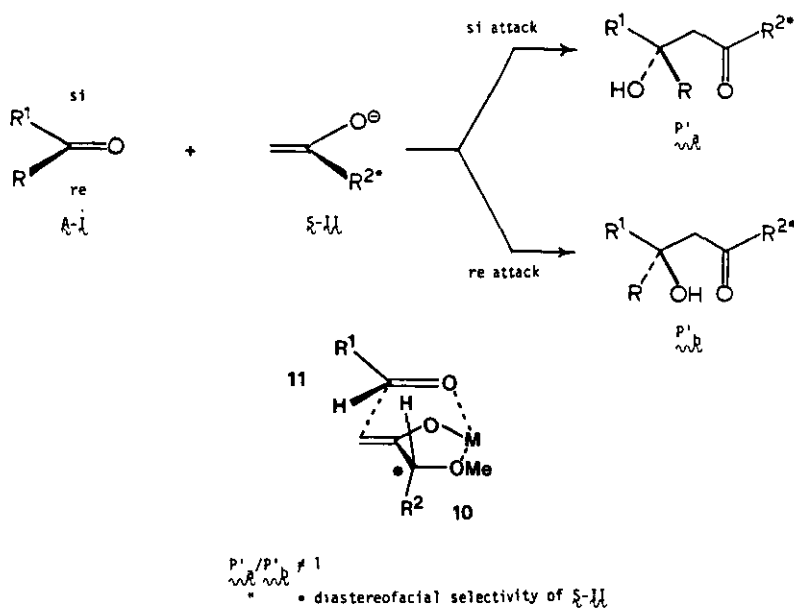

as the chirality in both  $S-I$  and  $S-II$  affects the stereochemical course of the reaction. By simple (and naive) analysis, the ratio of products,  $R''_a/R''_b$  may be approximated to be  $(R_a/R_b) \times (R'_a/R'_b)$ . If this approximation holds, the  $R''_a/R''_b$  will be larger than either  $R_a/R_b$  or  $R'_a/R'_b$ . Since their diastereofacial selectivities complement each other,  $S-I$  and  $S-II$  are called a matched pair. In contrast, when  $S-I$  reacts with  $R-II^*$ , the ratio of products,  $R''_a/R''_b$ , may be approximated to be  $(R_a/R_b) \div R'_a/R'_b$ . Thus,  $R''_a/R''_b$  will be inferior to the larger of  $R_a/R_b$  and

\*  $R-II^*$ , the enantiomer of  $S-II$ , should have a diastereofacial selectivity that is equal in magnitude but opposite in selection to that of  $S-II$  (i.e.,  $R-II^*$  favors the re-attack transition state).

$R_a/R_b$ . Now that their diastereofacial selectivities oppose each other,  $S_{\text{I}}$  and  $R_{\text{II}}$  constitute a mismatched pair. The approximate multiplicativity of diastereofacial selectivities thus inferred unfortunately lacks rigorous theoretical justification, and therefore must be tested experimentally to be accepted. At the outset of this project we simply assumed its validity.

### 3. A New Strategy for Stereochemical Control

In natural products synthesis, we frequently encounter the need to build a new chiral center or centers on a chiral substrate. Scheme 4 formulates this transformation:  $^*A-C(x)$  (equivalent to  $S_{\text{I}}$  in Section 2) is converted to  $^*A(^*C_n)-C(z)$  where both  $C(x)$  and  $C(z)$  denote appropriate functional groups for the chemical operation.<sup>\*</sup> In order to achieve this task a chiral reagent  $^*B-C(y)$  (equivalent to  $S_{\text{II}}$  in Section 2) is allowed to react with  $^*A-C(x)$  to provide a mixture of stereoisomers

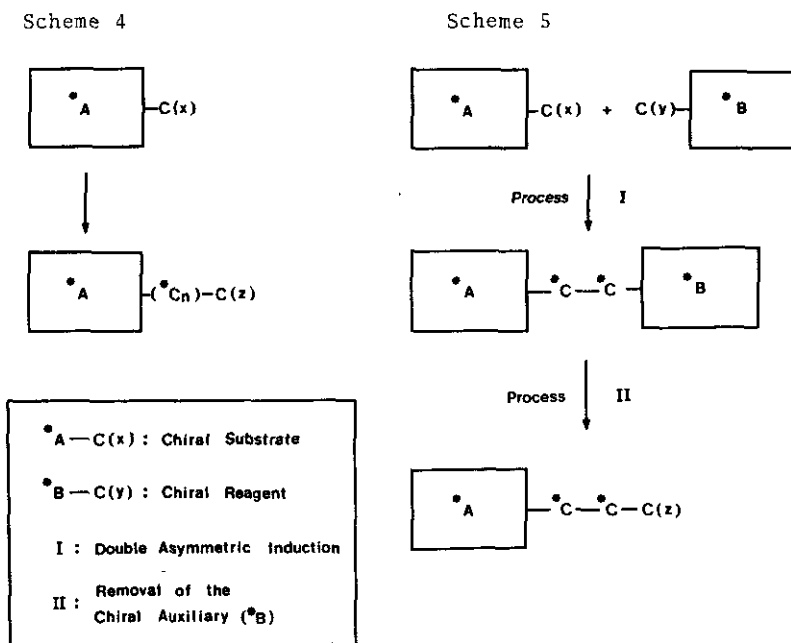

BOTH  $^*A$  AND  $^*B$  MUST BE ENANTIOMERICALLY PURE (HOMOCHIRAL),

expressed by  $^*A-^*C-^*C-^*B$  (process I). The reagent  $^*B-C(y)$  is so chosen that a high stereoselection (at  $^*C$ ) is achieved in this process. Having served this purpose, the chiral auxiliary  $^*B$  is removed in such a fashion so as to leave a functional group

<sup>\*</sup>  $^*A$  and  $^*C$  denote a chiral group and a chiral center, respectively.

C(2) for further transformation. From the analysis detailed in Section 2, it follows that (1) when the desired  $^*A-C-C-B$  is  $R''_R$ , the major product in the matched pair reaction, the resulting stereoselection should be higher than the diastereofacial selectivity of  $^*A-C(x)$ , being augmented by that of the reagent; (2) if the  $^*A-C-C-B$  happens to be  $R''_S$ , then the use of reagent of the opposite chirality (a mismatched pair) whose diastereofacial selectivity is substantially large enough to outweigh that of  $^*A-C(x)$  is recommended. Such reagents of either chirality (at B<sup>\*</sup>) can be, and have been, prepared.

In contrast to many cyclic systems, acyclic chiral substrates normally exhibit a smaller diastereofacial selectivity ranging from 1 to 5. Therefore, reagents which have a diastereofacial selectivity of >100 can meet the above demand. In this way a >100 : 1 stereoselection is expected for a matched pair, while even a mismatched pair brings about a minimal isomeric ratio of 1 : >20, the degree of stereoselection which is of practical significance in organic synthesis. Thus, the concept of multiple asymmetric induction discloses the possibility that the stereochemistry of organic reactions may be controlled by the chirality of reagents (and substrates) rather than substrates alone as it has been in the cases to date, and that the stereoselection one order of magnitude higher than that previously attained in the latter cases may accrue through this methodology. Let us see to what extent this possibility has been realized in actual experiments.

#### 4. Aldol Reaction <sup>1a</sup>

Before we discuss chiral enolate reagents newly developed for the asymmetric aldol reaction, it appears appropriate to present some salient stereochemical features of this well-known carbon-carbon bond-forming reaction. The reaction involves an aldehyde ( $12$ ) and an enolate ( $13$ ) and creates, in principle, two new chiral centers in the product ( $14$ ) (Scheme 6). When  $12$  is a chiral aldehyde and  $13$  is an enolate derived from an ethyl ketone, four possible diastereomeric products ( $14a-14d$ ) may be formed as indicated in Scheme 6.\*

\* For these stereochemical descriptions [syn, anti,  $\underline{Z}(0)$ , and  $\underline{E}(0)$ ], see ref. 5.

## Scheme 6

## NOMENCLATURE

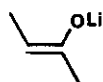
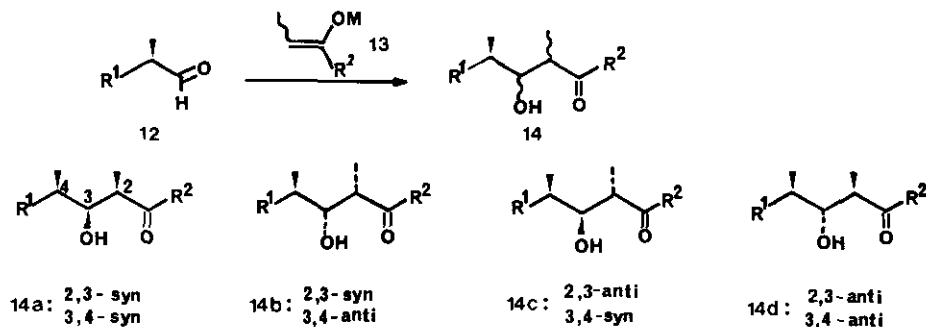

Z-ENOLATE

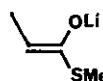

E-ENOLATE = Z(O)-ENOLATE

The aldol is influenced by many reaction parameters and thus its mechanism is complex, varying from one case to another. Today's discussion is confined to the reactions of a rather general type where the chair-type cyclic intermediate  $\downarrow$  (Zimmerman-Traxler model) (Scheme 7) can serve to rationalize experimental results.

## Scheme 7

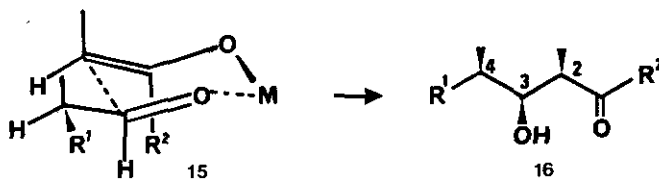

15 : Z(O)-ENOLATE  
 $\alpha$ (RE)-ENANTIOFACE  
ATTACK

Z(O),  $\alpha$  : 2,3-SYN  
3,4-SYN

Z(O),  $\beta$  : 2,3-SYN  
3,4-ANTI

E(O)  $\alpha$  : 2,3-ANTI  
3,4-SYN

E(O)  $\beta$  : 2,3-ANTI  
3,4-ANTI



The outcome of the reaction proceeding through  $15$  which delineates the case of  $\underline{Z(O)}$ -enolate approaching the  $\alpha$  (re)-face of the aldehyde is straightforward: The aldol product  $16$  should have the 2,3-syn, 3,4-syn stereochemistry. The other combinations for the assembly of the enolate and aldehyde are:  $\underline{E(O)}$ -enolate approaching the  $\alpha$ -face or  $\beta$  (si)-face of the aldehyde, and the  $\underline{Z(O)}$ -enolate, the  $\beta$ -face. The stereochemistry of the product in each case is tabulated. It is clear that (1) the  $\underline{Z(O)}$  and  $\underline{E(O)}$  geometries of the enolate are translated into the 2,3-syn and 2,3-anti stereochemistry of the aldol product, respectively, and (2) the enolate's approach to the aldehyde from the  $\alpha$ - or  $\beta$ -face determines the absolute configuration of the C-3 hydroxyl group created in the reaction. The  $\alpha$ - and  $\beta$ -face attacks correspond to the  $\beta$ - and  $\alpha$ -absolute configurations of the C-3 hydroxyl group of the product, respectively. Since the  $\beta$ -absolute configuration of the C-4 methyl group in  $16$  is "handed over" from the aldehyde, the 3,4-stereochemistry of  $16$  is syn in this case. Therefore, the stereochemical problem in the aldol reaction consists of two parts — the 2,3- and 3,4-stereochemical control.

One simplistic conformational analysis of the transition state has fortunately led to an expeditious solution of this problem. The relatively short O-B and C-B bond-lengths as well as the strong affinity of boron toward an oxygen lone pair would "tighten" the transition state and simultaneously a bulky ligand attached to the boron atom would exert a steric demand in the lower space of the chair ring. These factors could thus force the orientation of the aldehyde in the manner shown in  $15$ . This prediction has indeed been realized and, in a way, validates the Zimmerman-Traxler model, particularly in the case of boron-mediated aldol reaction.

The experimental results are briefly summarized in Scheme 8. Treatment of *S*-phenyl propionate ( $17a$ ) and ethyl cyclohexyl ketone ( $17b$ ) with 9-borabicyclo[3.3.1]nonyl trifluoromethanesulfonate (9-BBN triflate) ( $18$ ) effects the stereoselective formation of the corresponding  $\underline{Z(O)}$ -boron enolates  $17'a$  and  $17'b$ , respectively, which react with a variety of aldehydes to provide the racemic 2,3-syn-3-hydroxy-2-methyl-carbonyl compounds  $19a$  and  $19b$  with a stereoselection of at least 30 : 1. On the other hand, dicyclopentylborinyl triflate  $20$  converts *S*-tert-butyl propionate into  $17'c$ , which is capable of producing racemic 2,3-anti aldol products ( $21$ ), again with excellent stereoselection (>20 : 1). Although a number of methods for the stereoselective synthesis of racemic 2,3-syn- and anti-3-hydroxy-2-methylcarbonyl compounds are now available, the boron-enolate aldol reaction remains the method of choice in terms of overall selectivity, yield, and operational simplicity.

Scheme 8

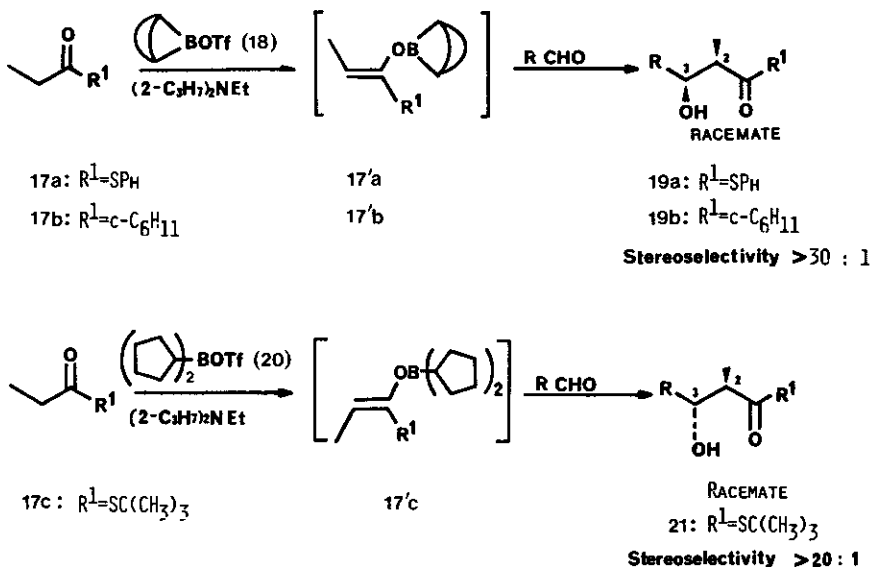

While the 2,3- problem quickly came to a successful end, the 3,4- problem consumed a great deal of our effort. One can readily recognize that the 3,4- problem concerns the relative disposition of the aldehyde and enolate, inasmuch as  $\alpha$  and  $\beta$  lead to  $14a$  and  $14b$ , respectively (Scheme 9). From the discussion in Section 3, this 3,4- stereochemical control clearly demanded the development of chiral enolate reagents whose diastereofacial selectivity (>100 : 1) was regarded at that time as unattainably high.

Scheme 9

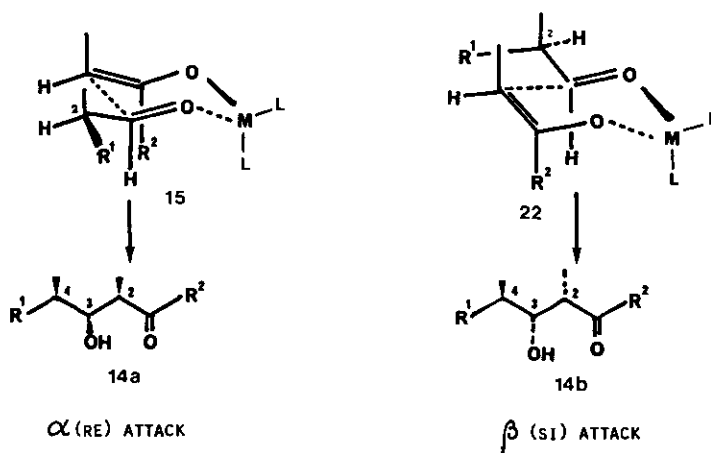

One of our very first tasks encountered in the aldol work was the construction of the 2,3-syn, 3,4-anti system (see  $24$ ) from (-)-dimethylglutaric hemialdehyde ( $23$ ). The aldol reaction of  $23$  with an achiral  $\underline{Z}(\text{O})$ -enolate, e.g.,  $17a$  provides an approximately 3 : 2 mixture of  $24$  and  $25$  which correspond to  $P_a$  and  $P_b$  discussed in Section 2 (Scheme 10). The 3 : 2 ratio is the diastereofacial selectivity of aldehyde  $23$  and represents roughly the degree of diastereoselection one can attain in the aldol reactions of  $23$  without recourse to double asymmetric induction.

Scheme 10

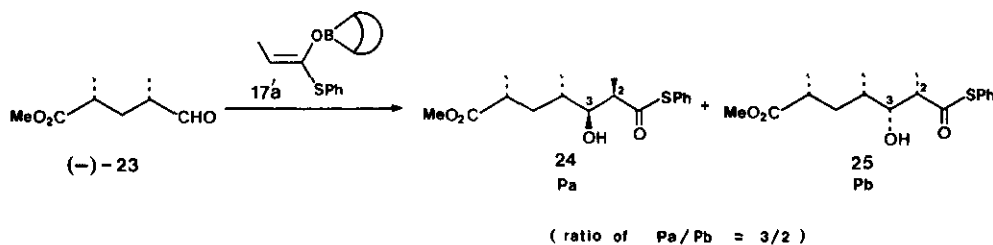

Many chiral  $\underline{Z}(\text{O})$ -enolates had been prepared and examined before those (S- or R- $26a,b,c$ .) shown below emerged as strong candidates for the solution of this 3,4-stereochemistry.<sup>6</sup> All of these reagents are readily prepared from commercially

Scheme 11

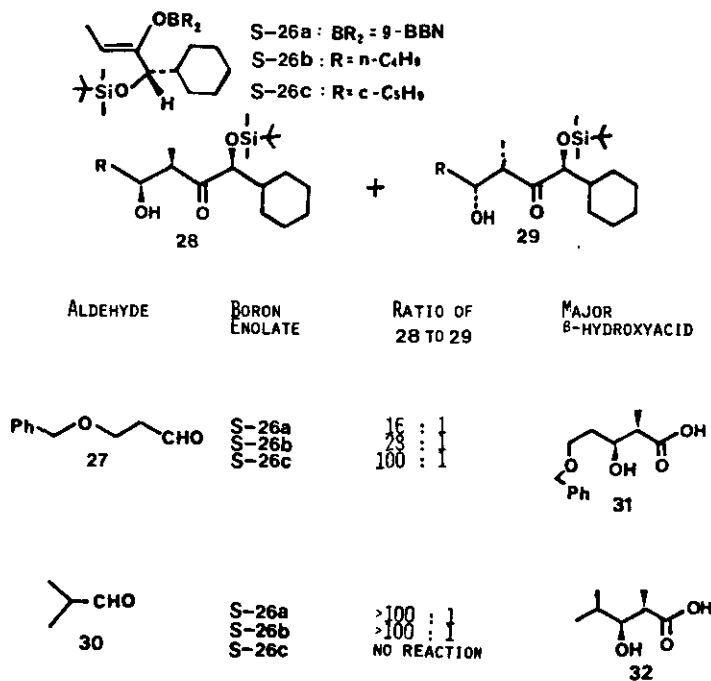

available, optically pure (*S* or *R*) mandelic acid via three steps and differ in the ligand attached to the boron atom. The diastereoselectivities of the reagents are impressive even by today's standards (Scheme 11). For instance, achiral aldehyde **27** undergoes aldol reaction with *S*-**26c**, the most stereoselective (but least reactive) boron enolate of the three (**26a**-**26c**) to provide a 100 : 1 mixture of diastereoisomers **28** and **29** (*R*=PhCH<sub>2</sub>O-CH<sub>2</sub>-CH<sub>2</sub>-). With isobutyraldehyde (**30**), an α-branched aldehyde, the selectivity of the reaction is very high [ $>100 : 1$  of **28** and **29** (*R*=2-Pr)] even with the least selective (but most reactive) boron enolate *S*-**26a**. Successive treatment of a mixture of **28** and **29** with hydrogen fluoride (or fluoride anion) followed by sodium metaperiodate provide the corresponding 2,3-syn-3-hydroxy-2-methylcarboxylic acids (**31** and **32**) with an enantiomeric excess higher than 98 %. These results meet the criteria set for the chiral reagents (Section 3).

We were then ready to tackle the first task mentioned earlier. Thus, the reaction of homochiral aldehyde (-)-**23** with homochiral enolate *S*-**26b** proceeded to provide two diastereoisomers **33** and **34** in a ratio of  $>100 : 1$  (Scheme 12). The change in the chirality of the enolate reagent brought about a reversal of the result: A combination of (-)-**23** and *R*-**26b** led to the formation of **33** and **34** in a ratio of 1 : 30

Scheme 12

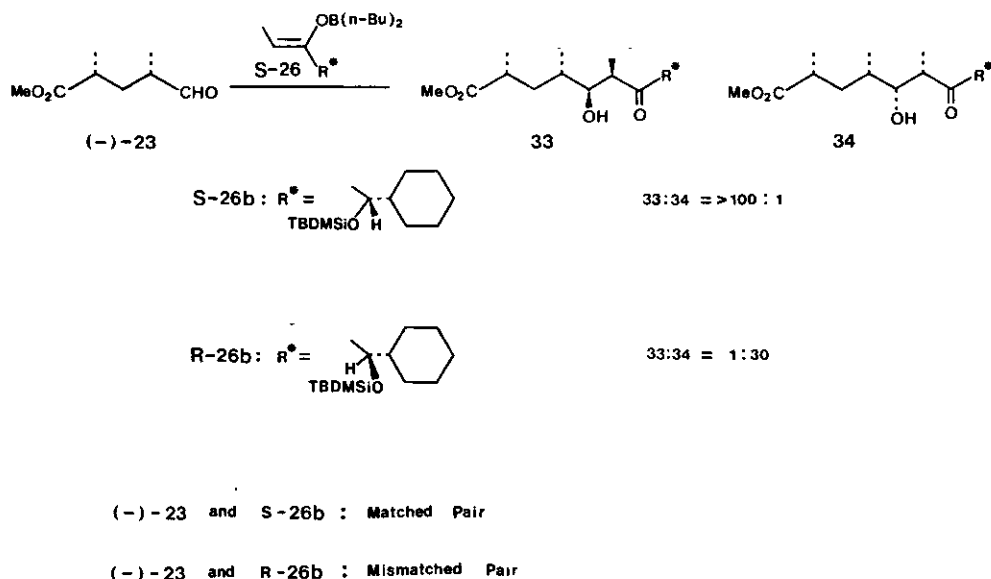

favoring the latter (34).<sup>7a</sup> The significance of these two reactions is three fold: (1) Both ratios are far superior to the ratio 3 : 2 obtained with an achiral enolate (see above), (2) the chirality of R\* in S-26b is directly correlated to the stereochemistry at the 3,4-positions of the reaction products, and thus either the 2,3-syn, 3,4-anti or 2,3-syn, 3,4-syn system can be constructed in a preselected manner, and (3) the two reactions, (-)-23 + S-26 and (-)-23 + R-26 represent matched and mismatched pairs, respectively, and the multiplicativity of the two diastereofacial selectivities (3 : 2 and 100 : 1) are roughly realized. The stereochemical course of the aldol reaction is now fully under control and the power of double asymmetric induction is clearly demonstrated.\*

Let us see how the aldol reaction has been utilized in the synthesis of 6-deoxyerythronolide B (35).<sup>7b</sup> Once the seco-acid aldol approach is adopted,<sup>1b,2</sup> designing a synthetic scheme is straightforward. Splitting the seco-acid derivative (36),

Scheme 13

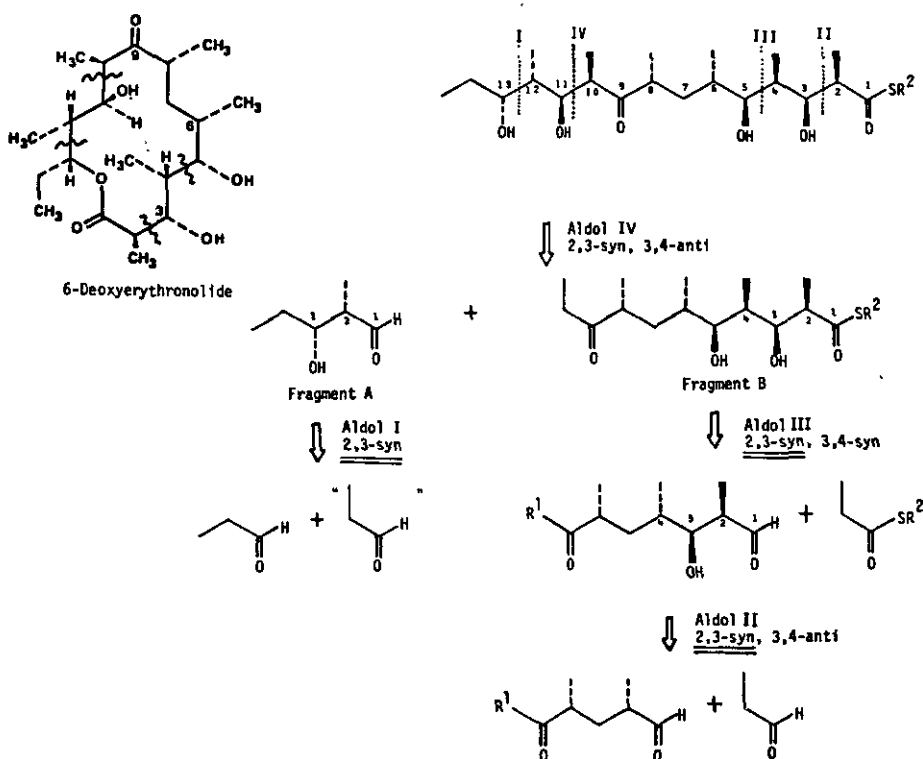

\* These examples represent one of the first such demonstrations of stereochemical control by means of multiple asymmetric induction. Also see ref. 3d.

drawn in a zigzag fashion, into fragments A and B immediately suggests the order of the aldol reactions to be used in the synthesis. Aldol I (involving propanal 37 and its 3-carbon equivalent) produces fragment A, while aldol II (37 and 38) and III (39 and equivalent of 37) complete a synthesis of fragment B. Finally, both fragments are combined via aldol IV. Note that aldol I, II, and III all concern the creation of 2,3-syn stereochemistry, a task that can be readily achieved with 26a, b, c.

The first step of the seco-acid synthesis has already been discussed (Scheme 14). The reaction of (-)-23 with 26b provides the desired product with >100 : 1 stereoselection. The aldol product 33 which, after removal of the chiral auxiliary (HF and then NaIO<sub>4</sub>), is converted to the Prelog-Djerassi lactonic acid 40 in optically pure form (>98 % e.e.). Addition of the C-1, C-2 fragment (see 36) to 41, the aldehyde

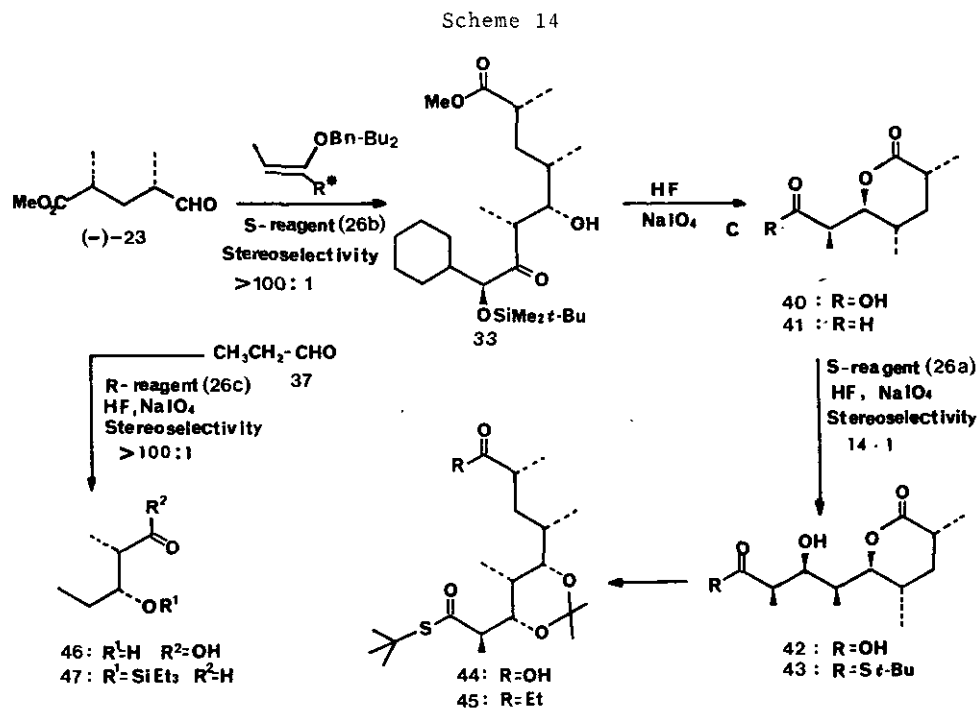

corresponding to 40, uses the S-chiral reagent 26a (Aldol III). Thus, reaction of the aldehyde 41 provides (with 14 : 1 stereoselection) the major product which, upon standard treatment (see 33 to 40), is transformed to the carboxylic acid 42 and then to its thiol ester 43. After modification of the functional groups of 43 through a series of routine reactions the resulting carboxylic acid 44 is further converted to the corresponding ethyl ketone 45, which is an equivalent of fragment B. The

enantioselective synthesis (selectivity >100 : 1) of the hydroxy acid **46** corresponding to fragment A is readily achieved using propanal (**37**) and *R*-chiral reagent **26c** (Aldol I). A sequence of standard operations converts **46** into aldehyde **47**. Thus, eight chiral centers out of the ten embedded in the target molecule **35** have been created with remarkable efficiency and stereoselection. At this stage the overall yield is 30 % and overall stereoselectivity is approximately 90 %. The remaining tasks consist of the final aldol coupling (aldol IV in Scheme 13) of fragment A with B and the macro-lactonization of the resulting seco-acid derivative, both of which have been successfully executed, as outlined in Scheme 15.

Scheme 15

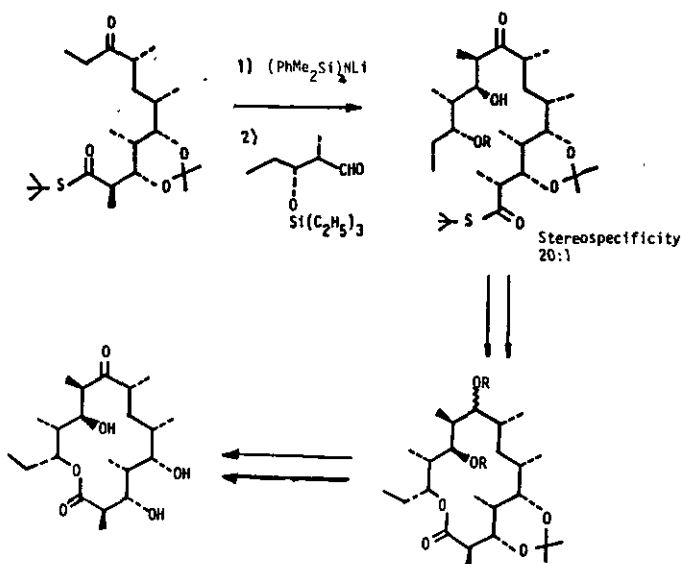

The macro-lactonization has already been adequately reviewed, and the stereochemical control in aldol IV is methodologically different from what has been discussed above.\* Therefore, both transformations in the final stages of the 6-deoxyerythronolide B synthesis are omitted from this discussion.

\* Aldol IV is distinguished from aldol I-III in that it (IV) involves the coupling of two structurally prefixed components.

## 5. Diels-Alder Reaction

This reaction effects one of the most efficient organic transformations in that it (D.A. reaction) normally proceeds in excellent yield and creates, in principle, four chiral centers as exemplified in Scheme 16. The pericyclic reaction of two chiral components, diene **48** and dienophile **49** can hypothetically produce  $2^4=16$

Scheme 16

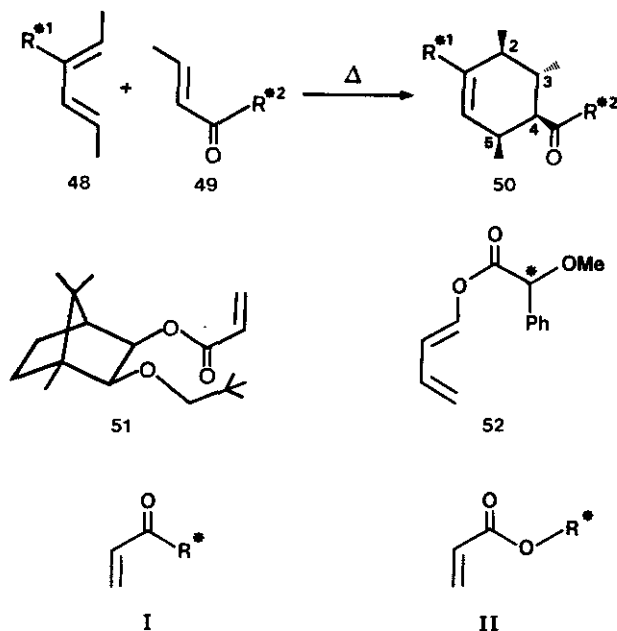

stereoisomers, isomeric at the C(2), C(3), C(4), and C(5) atoms in **50**. The attainment of the potential stereoselection requires the advantageous (and simultaneous) exercise of, at least, four elements which govern the stereochemical course of the reaction. These elements are indeed well known: *cis*-addition, *endo*-addition, and diastereofacial selectivities of both the chiral ene and diene.\* With regard to the last factors, diastereoselectivities have indeed received renewed interest in recent years, and some excellent chiral reactants such as dienophile **51**<sup>8</sup> and diene **52**<sup>9</sup> are now available. After a close review of this previous development, our attention has been directed to the design of chiral dienophiles in which a chiral auxiliary ( $R^*$ ) is attached one atom closer to the three-carbon enone unit (Type I) than in the reagents (type II) often used earlier (see **51**).

\* The last factor (the selectivity of the chiral diene) is closely related with the orientation of **48** to **49** in the transition state (regio-chemistry of **48**).



The type I reagent of choice was **53**.<sup>10</sup> Coupling of **53** with cyclopentadiene (**54**) in the presence of  $\text{ZnCl}_2$  at  $-40^\circ\text{C}$  is completed within 1 h to provide two endo-products **55** and **56** in a ratio of  $>100 : 1$ , in addition to a small amount of the exo-isomers (Scheme 17). Likewise the reaction of **57**, a homolog of **53**, with **54** under the ident-

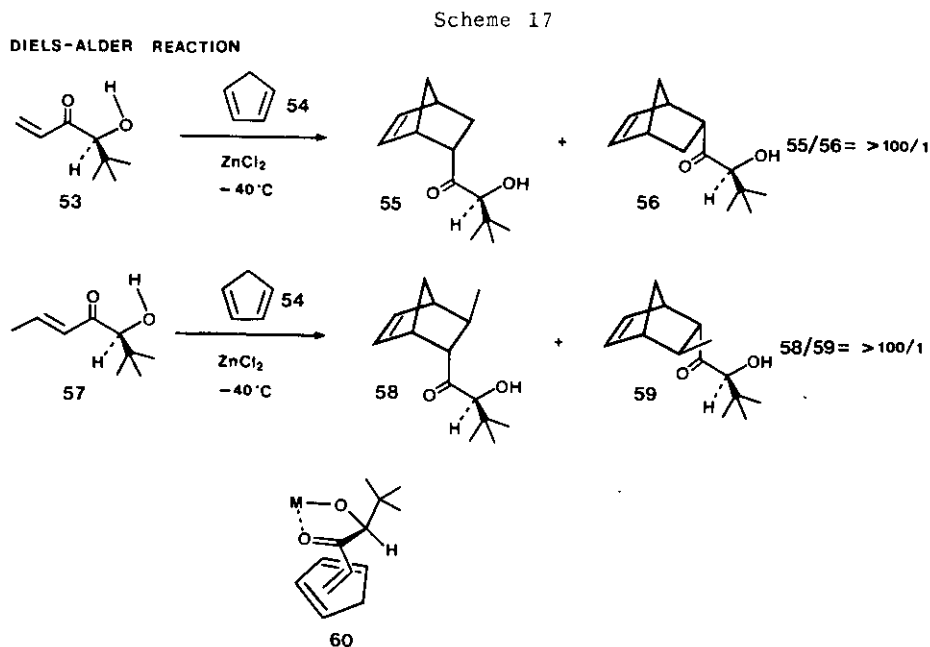

ical conditions proceeds smoothly with equally high stereoselection (**58** : **59** =  $>100 : 1$ ). The results of these and other related experiments disclose, at least, two important features of the D.A. reaction. First, the coordination of the Lewis acid catalyst with the  $\alpha$ -hydroxyketone moiety of the dienophile **53** leads to the formation of a rigid five-membered chelate, thus making the two diastereotopic faces of the enone system highly distinguishable (see **60**). Second, from the established absolute configurations of **53** and **55** (and also **57** and **58**), one concludes that, within the chelated framework of **60**, the D.A. reaction proceeds with the enone fragment in its cisoid (synplanar) conformation, at least, in these particular instances [as opposed to the transoid conformation often postulated earlier for chiral esters of type II (see above)].

A variety of dienes react with **53** and **57**.<sup>10</sup> In the three examples shown in Scheme 18 the cycloaddition reaction provides a single adduct to the detection limits of  $^1\text{H}$  NMR spectroscopy (270 Hz). Oxidative removal of the chiral auxiliary group from the adduct (cf. a similar transformation of the aldol products discussed in Section

4) leads to a homochiral product (at minimum 98 % e.e.), which serves as an intermediate for the synthesis of a natural product. Example 1. Reaction of S-53 with excess butadiene (61) in the presence of ZnCl<sub>2</sub> gives rise to 62 which is in turn

Scheme 18

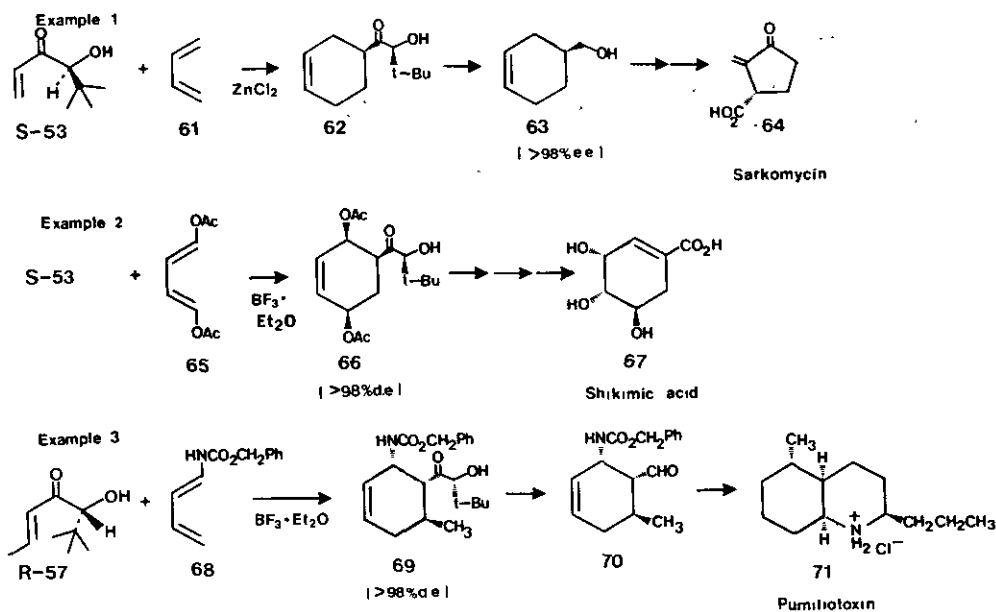

transformed via three steps to alcohol 63 (98 % e.e.). Conversion of the enantiomer of 63 to natural sarkomycin 64 has already been documented.<sup>10</sup> Example 2. 1,4-Diacetoxybutadiene (65) and S-53 are coupled with the aid of BF<sub>3</sub>·OEt<sub>2</sub>. Product 66, which is the exclusive stereoisomer of this cycloaddition, is then subject to a series of six transformations analogous to those used earlier to provide optically pure shikimic acid (67). Example 3. A mixture of R-57 and BF<sub>3</sub>·OEt<sub>2</sub> is allowed to react with excess diene 68 to provide an adduct 69 with >100 : 1 diastereoselection, which is in turn converted in two steps to aldehyde 70. Conversion of 70 to the hydrochloride of (+)-pumiliotoxin 71 follows the published procedure.<sup>12</sup>

The above examples of single asymmetric induction clearly demonstrate that our chiral dienophilic reagents 53 and 57 are highly diastereofacially selective (>100 : 1), and satisfy the prerequisites for successful double asymmetric induction which is, of course, the issue of our prime concern. In order to examine the validity of the matching and mismatching concept as applied to the D.A. reaction, a set of experiments

has been carried out, using butadienyl phenylacetate ( $\lambda\lambda$ ), as an achiral diene and S- and R-O-methyl mandelates (S- $\lambda\lambda$  and R- $\lambda\lambda$ ) as chiral dienes. Diene  $\lambda\lambda$  has a moderate diastereoselectivity (Scheme 19).

Scheme 19

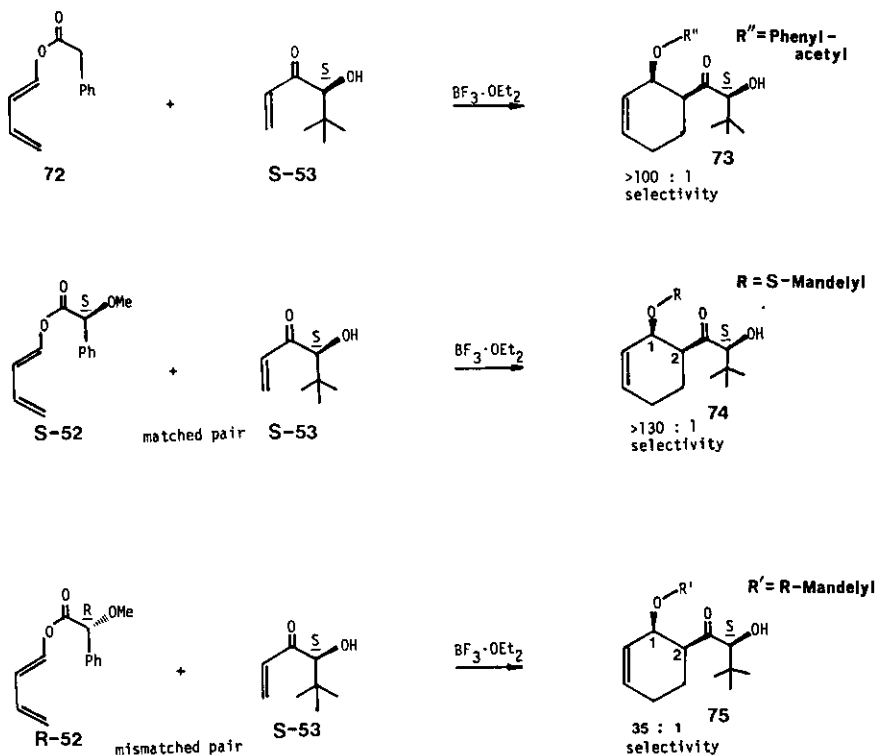

The first experiment involving S- $\lambda\lambda$  and  $\lambda\lambda$  reconfirm, the high diastereofacial selectivity of S- $\lambda\lambda$  as applied to  $\lambda\lambda$ , which is close in structure to chiral diene  $\lambda\lambda$ . As expected,  $\lambda\lambda$  is the major product of the reaction which proceeds with  $>100 : 1$  stereoselection in the presence of the catalyst  $\text{BF}_3 \cdot \text{OEt}_2$ . In the next two experiments, two chiral reactants are coupled under the conditions identical to those used in the first one. The reaction of diene S- $\lambda\lambda$  with dienophile S- $\lambda\lambda$  provides a  $>130 : 1$  mixture of  $\lambda\lambda$  and its diastereoisomer, while the ratio of adduct  $\lambda\lambda$  and its stereoisomer obtained from diene R- $\lambda\lambda$  turns out to be  $35 : 1$ .<sup>10b</sup> Note that in the latter two cycloadditions the absolute configurations of the two major products  $\lambda\lambda$  and  $\lambda\lambda$  are the same at the C-1 and C-2 centers and are directly correlated with the chirality of  $\lambda\lambda$ , thus the stereochemistry of these reactions is

controlled through the selection of  $\underline{R}$  or  $\underline{S}$ - $\mathfrak{S}_3$ . In a manner similar to that demonstrated in the aldol reaction (Section 4), this outcome reflects the large diastereofacial selectivity of  $\mathfrak{S}_3$  as compared with that of  $\mathfrak{S}_2^*$ . The different ratios (130 : 1 and 35 : 1) observed in the above reactions obviously correspond to matched and mismatched pairs, respectively. Thus, both  $\mathfrak{S}_3$  and  $\mathfrak{S}_2$  have been proved to be capable of creating new chiral centers in a predictable manner.

#### 6. Some Comments on the Aldol and Diels-Alder Reaction

The two reactions discussed in the preceding sections are proposed to proceed through the transition states depicted in  $\mathfrak{76}$  and  $\mathfrak{60}$ . In both cases, the two sides (or faces) of the plane defined by the  $sp^2$  carbon atoms, and perpendicular to the  $\pi$  cloud, of

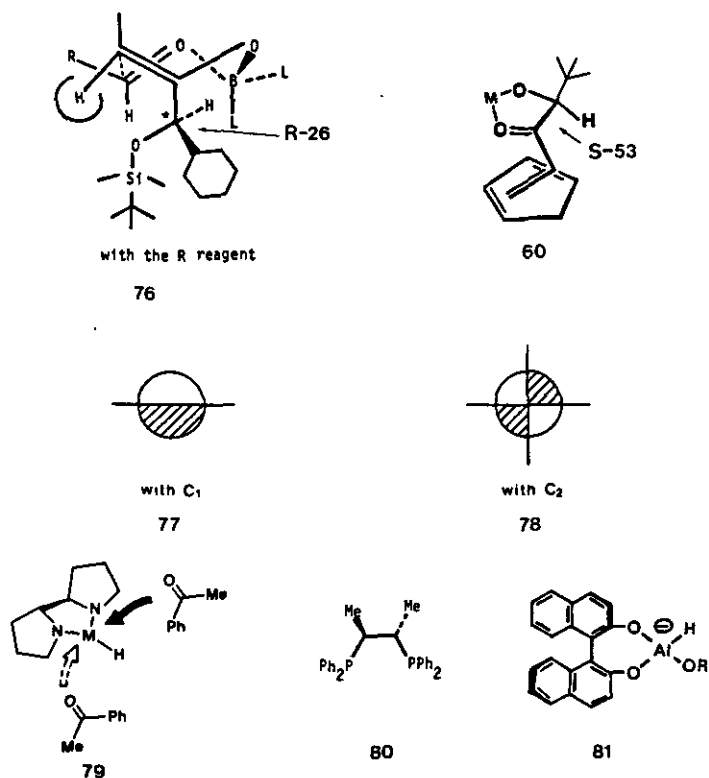

the chiral reagent  $\underline{R}$ - $\mathfrak{S}_3$  (in  $\mathfrak{76}$ ) [and also of  $\underline{S}$ - $\mathfrak{S}_3$  (in  $\mathfrak{60}$ )] are distinctly diastereo-

\* The chiral center of  $\mathfrak{S}_2$  is close to the reaction site, and thus the diastereofacial selectivity of most chiral dienes normally encountered in the synthesis is smaller than that of  $\mathfrak{S}_3$ . Therefore, the chirality of  $\mathfrak{S}_2$  would control the stereochemistry of most double asymmetric reactions.

topic (as shown in a more schematical manner in  $\lambda\lambda^*$ ). Thus a reacting counterpart (the aldehyde in  $\lambda\lambda$  and cyclopentadiene in  $\lambda\lambda$ ) is forced to approach the reagent almost exclusively from one "open" side. The presence of an asymmetric center in each reagent, of course, is responsible for the resulting high diastereoselectivity of the reaction, and the reagent lacks any symmetry element ( $C_1$  symmetry). Another design of chiral reagents is based on the concept of axial symmetry, in particular that of  $C_2$  (see  $\lambda\lambda$ ), the advantage of which is clearly seen in a hypothetical case of hydride reduction of acetophenone (see  $\lambda\lambda$ ). Assuming a four-membered transition state for this reaction, one would expect that the ketone approaches the five-membered diaza-metallocycle from the two directions (see the solid and broken arrows) with the orientations indicated in  $\lambda\lambda$  [the methyl on the right\*\* and phenyl on the left side of the carbonyl in the top approach (solid arrow) and the reverse in the bottom approach (broken arrow)]. Both approaches result in the formation of S-1-methylbenzyl alcohol. Thus, with a chiral reagent of  $C_2$ -symmetry a substrate is allowed to enter one of the two stereochemically equivalent quadrants (non-shaded parts of the circle in  $\lambda\lambda$ ). The space is now limited and thereby the stereoselection will be enhanced (cf.,  $\lambda\lambda$  and  $\lambda\lambda$ ). For the aldol and Diels-Alder reactions, the reagents of  $C_1$  symmetry have been devised because both reactions involve a multicentered (6-membered) transition state, which demands a large space and can be accommodated by a hemisphere but perhaps not by a quadrant in most cases. In contrast, some other reactions are not as space-demanding; indeed several excellent reagents of  $C_2$  symmetry are now known as exemplified by Chiraphos ( $\lambda\lambda$ ) for homogeneous catalytic hydrogenation and also by the Binap-Al reagent  $\lambda\lambda$  in ketone reduction. Sharpless' titanium reagent for epoxidation may be included in this category and is discussed in the next Section.

#### 7. Epoxidation of Allylic Alcohols

Sharpless' reagent consists of titanium tetraisopropoxide, tert-butyl hydroperoxide, and diethyl (+)-or (-)-tartrate (Scheme 20). With (+)-tartrate the oxidant approaches the allyl alcohol from the topside of the plane shown in  $\lambda\lambda$ , whereas the bottom side

\* The empty and shaded sides indicate the side open for the attack of a reactant and the blocked side, respectively.

\*\* As it is drawn in  $\lambda\lambda$ .

## Scheme 20

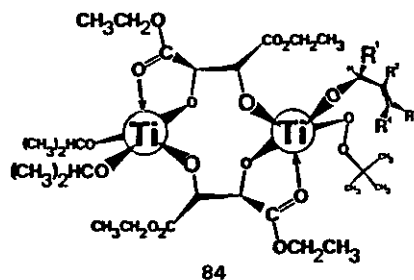
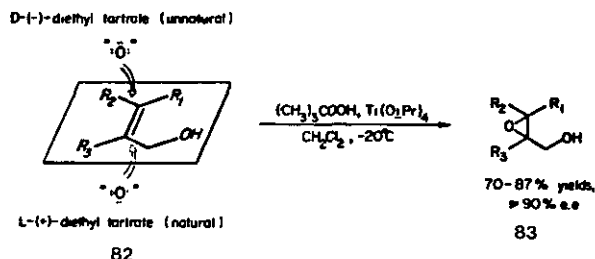

is open for the (-)-tartrate reagent\*, giving rise to the corresponding optically active epoxy alcohols  $\mathfrak{R}_3^2$ . This asymmetric epoxidation (hereafter abbreviated as A.E.) is proposed to proceed through the reagent-substrate complex  $\mathfrak{R}_4^A$ , which exhibits the high face-selection (demonstrated in this reaction) which approaches 100 : 1 in many cases. Therefore, we became interested to see if this A.E. verifies the concept of multiple asymmetric induction, thus being capable of constructing two new chiral centers on a chiral substrate in a predictable manner. One way to demonstrate its validity is to achieve, in a general and systematic manner, the stereoselective synthesis of all eight aldohexoses, each of which has four chiral hydroxymethylene groups. Our strategy is based on a reiterative two-carbon extension cycle, and its double application leads to the chiral centers embedded in the sugars.<sup>13</sup>

The device of the cycle is straightforward: It involves four key transformation (Scheme 21). I. Conversion of an aldehyde into its corresponding E- and Z-allylic alcohols (or their precursors) via the known Wittig olefination. II. Sharpless' A.E. III. Treatment of the epoxy alcohol with benzenethiolate anion in a basic medium. IV. The Pummerer reaction of the sulfide followed by hydrolysis.

\* The reagent has approximate  $D_2$  symmetry, cf.,  $\mathfrak{R}_4^A$ .

Scheme 21

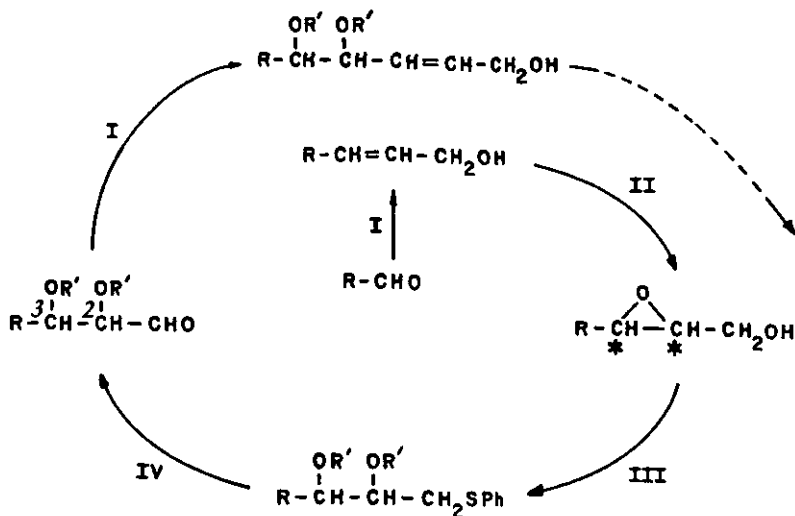

Of prime concern is the doubly asymmetric induction for which the allylic alcohol **85** derived from *D*-glyceraldehyde was chosen as a model (Scheme 22). Treatment of **85**

Scheme 22

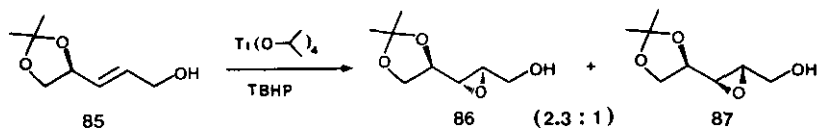

Scheme 23

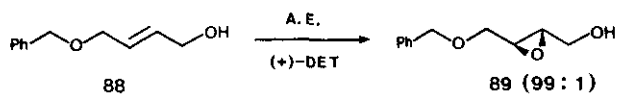

with titanium tetra-isopropoxide and tert-butyl hydroperoxide (Sharpless' reagent without diethyl (+)- or (-)-tartrate) provides a 2.3 : 1 mixture of epoxy alcohols **86** and **87**. This ratio (2.3 : 1) that represents the diastereofacial selectivity of **85** is much smaller than that of the chiral epoxidizing agent, as reconfirmed with the A.E. reaction of epoxy alcohol **88**, providing **89** with a 99 : 1 stereoselection (Scheme 23). All the conditions necessary for the stereochemical control of epoxidation in a double asymmetric reaction appears to have been met. The asymmetric epoxidation of **85** with (+)- and (-)-tartrate proceeds smoothly to provide epoxy alcohols **87** and **86** in ratios of 22 : 1 and 1 : 90, respectively (Scheme 24).<sup>13b</sup> As predicted and also verified with these results, **85** with A.E.-(+)-DET and A.E.-(-)-DET constitutes mismatched and matched pairs, respectively. Under basic conditions both **86** and **87** are in equilibrium with the corresponding terminal epoxides (Payne rearrangement) which can be trapped with benzenethiolate anion to provide dihydroxysulfides **90** and **91** in excellent yields, respectively.

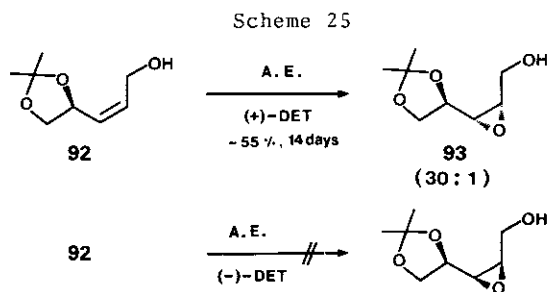
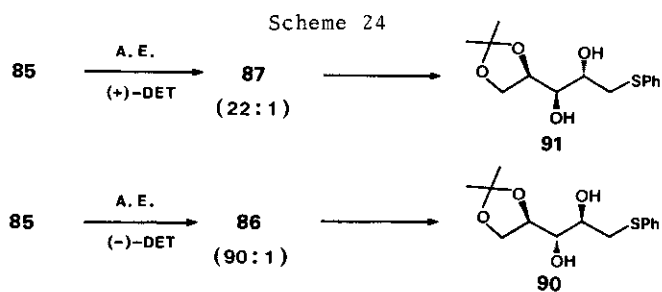

In contrast to the successful stereocontrol exhibited above for **85**, the Z-allylic alcohol **92** is found to react with the A.E. reagent extremely slowly (Scheme 25): With (+)-DET the epoxidation reaches only 55 % completion in 14 days at -20°C. However, the stereoselectivity is excellent favoring the formation of **93** in a 30 : 1 ratio. With (-)-DET, the reaction is too slow to be practical. As originally envisioned and described above, our basic cycle is intended to create



two new chiral centers using two elements of stereocontrol: the Wittig reaction (Z- and E-olefin) and A.E. Since one of them now cannot be used fully to our advantage, we must seek an alternative. Let me summarize the results we have seen thus far. The cycle (Scheme 26) leading to the 2,3-erythro products **94** via the E-isomer **95** is satisfactory, but, the A.E. of the Z-isomer **96** in the 2,3-threo series **97** often proceeds intolerably slowly. The stereocontrolling element thus lost is now replaced by another and the cycle is modified as outlined below.

Scheme 26

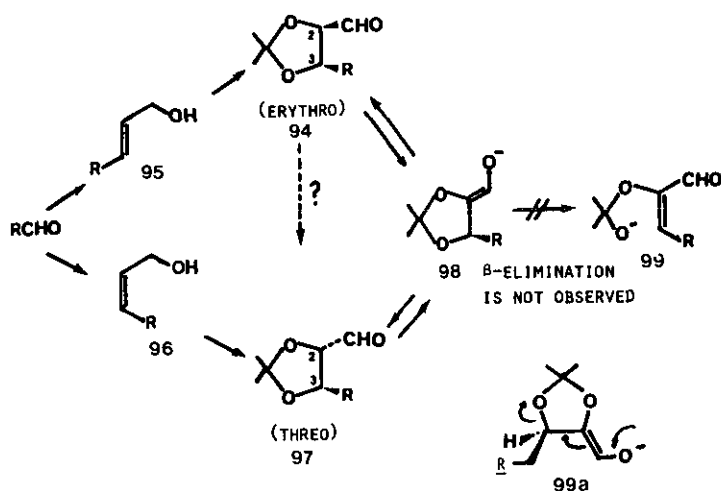

In compounds **94** and **97** the proton at C-2 is  $\alpha$  to the aldehyde group and thus epimerizable. From the expected stability of **97** relative to **94**, the latter which is readily obtainable can be equilibrated to give mainly **97**, which has been up to now of limited access. The acetonide chosen as a protecting group apparently suppresses the potential complication of a  $\beta$ -elimination (**98** to **99**) inasmuch as the acetonide group helps maintain orthogonality between the enolate  $\pi$  system and the  $\beta$ -alkoxyl substituent (see **99a**). Thus, treatment of several compounds represented by the general formula **94** with potassium carbonate in methanol at 25°C indeed effects smooth isomerization (>20 : 1). Incorporation of this critical epimerization technique in our basic cycle leads to the satisfactory synthe-

sis of all possible stereoisomers (four in one cycle).

Our final version is shown in Scheme 27, using the pentoses as illustration. The epoxy alcohol **86** undergoes ring opening to provide **90** which is converted to the acetonide **90a** through kinetically controlled acetonation followed by oxidation and

Scheme 27

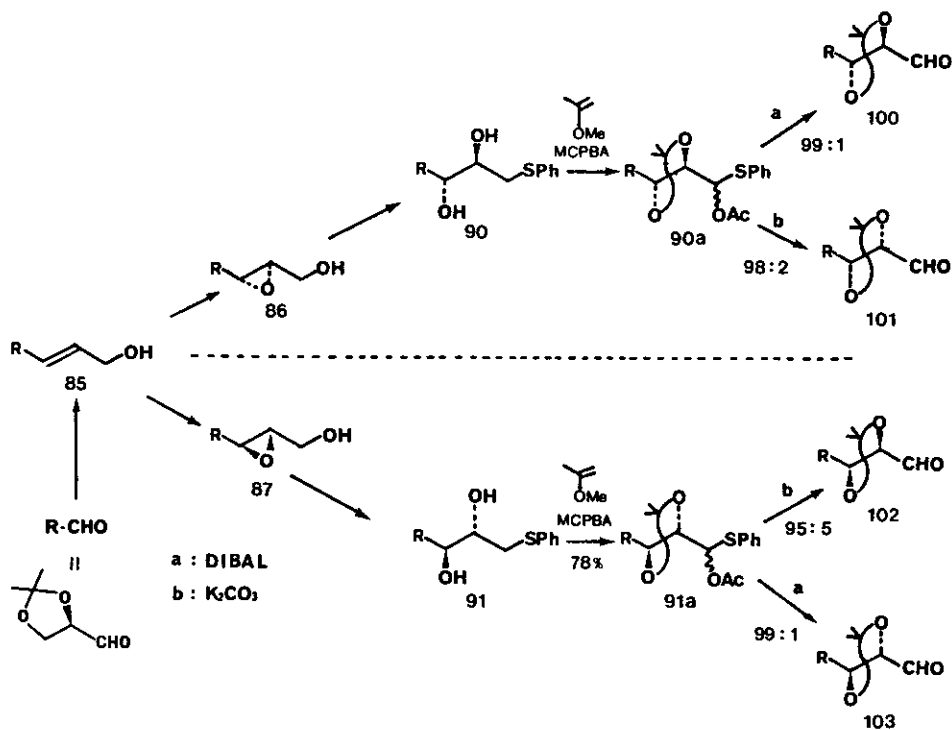

acetylation. Reaction of **90a** with Dibal provides, virtually without epimerization, a product (**100**) which proves to have the ribose configuration. Compound **90a** can also be converted to the C-2 epimer of **100**. Thus, treatment of **90a** with potassium carbonate in methanol causes hydrolysis of the acetoxythioacetal group and epimerization at the C-2 center to give a mixture of **101** and **100** in a 98 : 2 ratio. Compound **101** has the arabinose configuration. The acetonides (**102** and **103**) of xylose and lyxose are prepared in exactly the same manner. The key intermediate **91a** obtained from **87** via **91** provides **102** and **103** in the manner indicated in the scheme.

In this way a highly efficient route from the same intermediate  $\mathbf{85}$  to either the erythro- or threo-2,3-dihydroxy aldehydes has been established. It is obvious that the success of the above scheme depends heavily upon high asymmetric induction realized by the titanium-catalyzed epoxidation with (+)- or (-)-tartrates. The diastereofacial selectivity of this reagent outweighs the influence of the pre-existing chirality in the allylic alcohol. Now that efficient, practical routes from a chiral or achiral aldehyde to all the four possible bishomologated aldehydes

Scheme 28

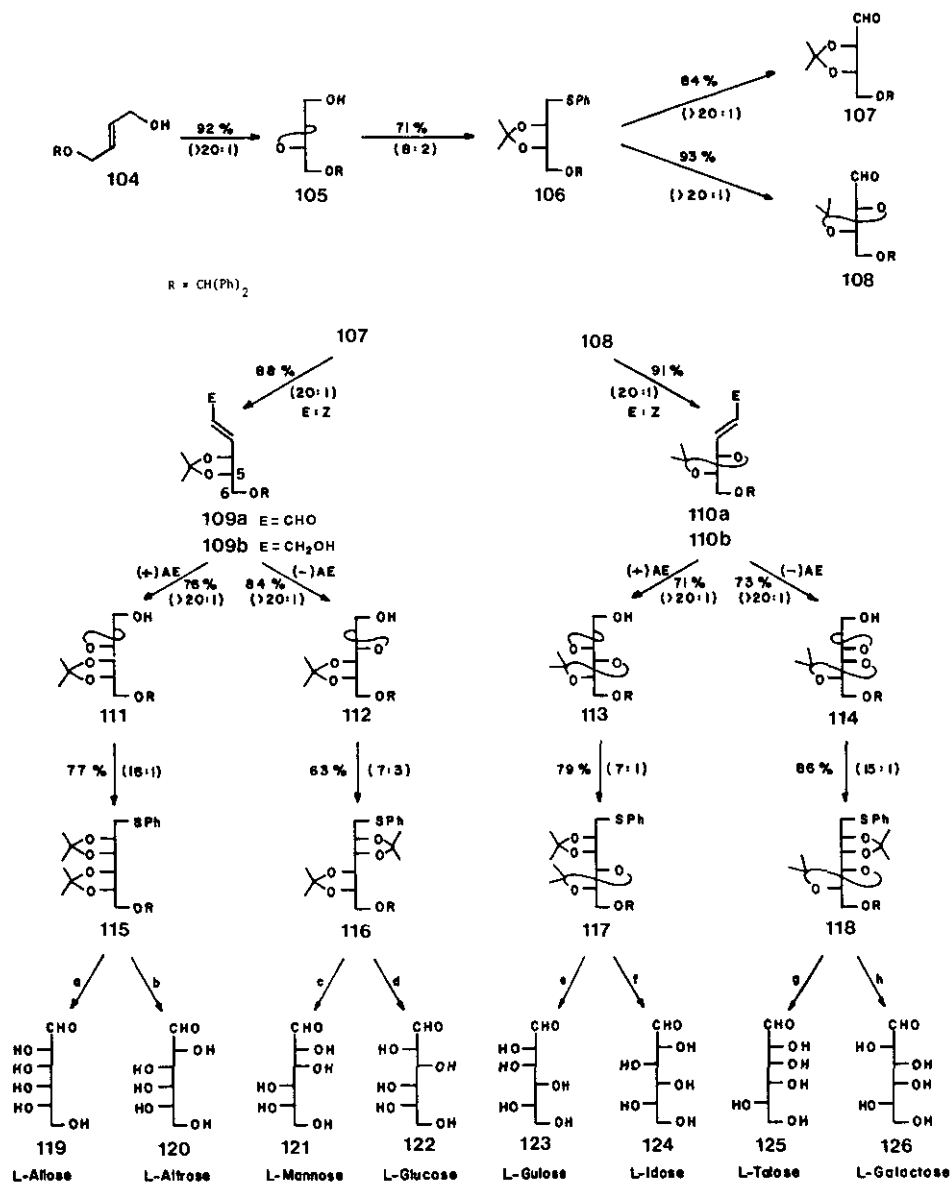

have been established, these final products are ready for a second two-carbon extension. Indeed, the synthesis of all the possible hexoses has now been completed, as shown in Scheme 28.

The top row of the scheme represents the first cycle of the hexose synthesis, which begins with a single building block, 4-benzhydryloxy-(E)-but-2-en-1-ol (104), a compound which is readily prepared from (Z)-2-butene-1,4-diol. Step I of the extension cycle is therefore eliminated in this initial case. Conversion of 104 into 107 and 108 completes the first cycle, and the conversion of 107 and 108 into 119 to 126 constitutes the entire set of the second cycle. The yield and selectivity are described for each step. I am not going into the details of the sequences leading to all hexoses. It suffices to say that all steps in this scheme except for the steps 112 - 116 proceed with remarkable regio- and stereoselection. Since the mirror image of every compound can be prepared by simple exchange of the chiral ligand (tartrate ester) in the A.E. reaction, the formal synthesis of the D-hexoses has also been achieved. This achievement adequately proves that the concept of matching and mismatching is valid in the A.E. reaction as well.

#### 8. Concluding Remarks

The power of the strategy based on the concept of multiple asymmetric induction has now been amply demonstrated. In the process of creating a new chiral center or centers, the reagent used in a matched pair augments the stereoselectivity intrinsic to the substrate, whereas the stereochemical course of a mismatched reaction is governed by the diastereoselectivity of the reagent. There is no reason to believe that the validity of multiplicativity of two (or more) diastereoselectivities is limited either to the cases of the above three major organic reactions or to the cases of the acyclic systems used to illustrate this concept. Therefore, the introduction of highly diastereoselective reagents into organic synthesis has brought about an era characterized by the evolution from substrate-controlled to reagent-controlled organic reactions. The multiplicativity of diastereoselectivities is only approximate, and not precise. This is so because our simple analysis completely ignores many factors which are considered to play a minor role in the face selection, e.g., such interactions that arise in the regions remote from the reaction site. All of the examples quoted in this lecture show that the stereoselectivities in both matched and mismatched pairs are somewhat lower than those calculated from the diastereoselectivity of each reactant partici-

pating in the reaction. This lowering is in all likelihood caused by these minor factors.

I conclude this presentation by pointing out some interesting features of multiple asymmetric induction. It is obvious that the two (or more) reactants involved in a reaction must be homochiral in order to gain full control of its stereochemistry in the manner described above. Needless to say, the resulting product is optically active. For example, we have succeeded in synthesizing L-glucose, but we are unable to prepare racemic glucose directly and with equal efficiency. Nature rarely synthesizes d,l-mixtures. Perhaps there is no pressing demand for racemates when the corresponding enantiomers can be made.

#### ACKNOWLEDGMENTS

With great pleasure I thank major contributors in several areas of the chemistry discussed in this chapter: Aldol; Drs. W. Choy, M. Hirama, S. Mori, Sk. A. Ali, and D. S. Garvey; Diels-Alder; Drs. L. A. Reed, III, W. Choy, and Mr. J. T. Davis. It has also been a memorable and gratifying experience for me to have collaborated with Professor K. B. Sharpless in the carbohydrate research which mainly involved Drs. A. W. M. Lee, L. A. Reed, III, F. J. Walker, and Mrs. S. Y. Ko. The work and this writing have been supported by grants from the National Institutes of Health (AI15403, CA28337, T-32-CA09112) (USA), as well as Yoshitomi Pharmaceutical Industries (Japan) and Kao Corporation (Japan).

Drs. W. Choy, B. Imperiali, and H. Tobita have read and improved the written version of this lecture, and this assistance I gratefully acknowledge.

#### REFERENCES

1. For reviews, see (a) Masamune, S.; Choy, W. Aldrichimica Acta 1982, 15, 47.  
(b) Masamune, S.; McCarthy, P. A. in "Macrolide Antibiotics"; Omura, S. Ed.; Academic Press, New York, 1984.
2. Masamune, S.; Bates, G. S.; Corcoran, J. W. Angew. Chem. Int. Ed. Engl. 1977, 16, 585.
3. For earlier discussions on this subject, see (a) Horeau, A.; Kagan, H.-B.; Vigneron, J.-P. Bull. Soc. Chim. Fr. 1968, 3795. (b) Izumi, Y.; Tai, A. in "Stereodifferentiating Reactions", Academic Press, New York, 1977. (c) Heathcock, C. H.; Pirrung, M. C.; Buse, C. T.; Hagen, J. P.; Young, S. D.; Sohn, J. E. J. Am. Chem. Soc. 1979, 101, 7077. (d) Masamune, S.; Ali, Sk. A.; Snitman, D. L.;

- Gravey, D. S. Angew. Chem. Int. Ed. Engl. 1980, 19, 557.
4. Brown H. C.; Muzzio, J. J. J. Am. Chem. Soc. 1966, 88, 2811.
  5. Masamune, S.; Lu, L. D.-L.; Jackson, W. P.; Kaiho, T.; Toyoda, T. J. Am. Chem. Soc. 1982, 104, 5523.
  6. Masamune, S.; Choy, W.; Kerdesky, F. A. J.; Imperiali, B. J. Am. Chem. Soc. 1981, 103, 1566.
  7. (a) Masamune, S.; Pratt, A. Unpublished results. (b) Masamune, S.; Hiram, M.; Mori, S.; Ali, Sk. A.; Garvey, D. S. J. Am. Chem. Soc. 1981, 103, 1568.
  8. Oppolzer, W.; Chapis, C.; Guo, M. D. Tetrahedron Lett. 1982, 23, 4781.
  9. Trost, B. M.; O'Krongly, D.; Belletire, J. L. J. Am. Chem. Soc. 1980, 102, 7596.
  10. (a) Choy, W.; Reed, III, L. A.; Masamune, S. J. Org. Chem. 1983, 48, 1137.  
(b) Masamune, S.; Reed, III, L. A.; Davis, J. T.; Choy, W. Ibid. 1983, 48, 4441.
  11. Boeckman, Jr., R. K.; Naegly, P. C.; Arthur, S. D. J. Org. Chem. 1980, 45, 752.
  12. Overman, L.; Jessup, P. J. J. Am. Chem. Soc. 1978, 100, 5179.
  13. (a) Ko, S. Y.; Lee, A. W. M.; Masamune, S.; Reed, III, L. A.; Sharpless, K. B.; Walker, F. J. Science 1983, 220, 949. (b) Ko, S. Y.; Sharpless, K. B. unpublished results.