

## POLYVALENT PORPHYRINS. LIGANDS FOR STABILIZATION OF HIGH VALENT METALS

T. G. Traylor,\* Kevin Nolan, Robert Hildreth, and Thomas A. Evans  
 Department of Chemistry, University of California, San Diego,  
 La Jolla, California U.S.A. 92093

Abstract - The iron(III) complex of tetra(3,5-di-*t*-butyl-4-hydroxyphenyl)porphyrin can be oxidized by two electron equivalents with peracids or dioxygen and base to form a stable complex. This complex oxidizes phenols. Alternatively, in the presence of 1-methylimidazole, the Fe(III) complex is autoreduced to the hexacoordinated Fe(II) species. These reactions bear some resemblance to the catalytic processes occurring in horseradish peroxidase and cytochrome c peroxidase.

The reduction of dioxygen or hydrogen peroxide in biological systems provides both energy and biosynthetic pathways for the oxygenation of organic compounds. Common catalysts for these reactions as well as dioxygen transport are iron porphyrins shown below (P = propionic acid).

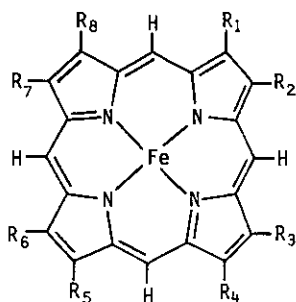

Protein	Function	R <sub>1</sub>	R <sub>2</sub>	R <sub>3</sub>	R <sub>4</sub>	R <sub>5</sub>	R <sub>6</sub>	R <sub>7</sub>	R <sub>8</sub>
Hemoglobin	O <sub>2</sub> transport	Me	Vinyl	Me	P	P	Me	Me	Vinyl
Myoglobin	O <sub>2</sub> transport	Me	Vinyl	Me	P	P	Me	Me	Vinyl
Cytochrome c peroxidase	electron transfer	Me	Vinyl	Me	P	P	Me	Me	Vinyl
Horseradish peroxidase	H <sub>2</sub> O <sub>2</sub> reduction	Me	Vinyl	Me	P	P	Me	Me	Vinyl
Cytochrome P-450	hydrocarbon oxidation	Me	Vinyl	Me	P	P	Me	Me	Vinyl
Cytochrome oxidase	reduction of O <sub>2</sub>	Me	Vinyl	Me	P	P	CHO	Me	Phityl

In the oxygen carriers such as hemoglobin, the iron, in the Fe(II) state, simply binds dioxygen reversibly.<sup>1</sup> The other proteins are in the Fe(III) resting state, but go through other oxidation states during the catalytic cycle. For example, cytochrome oxidase contains two hemein groups and two copper atoms per protein molecule.<sup>2</sup> A rough outline of its efficient four-electron reduction of dioxygen is shown in equation 1.<sup>2,3</sup>

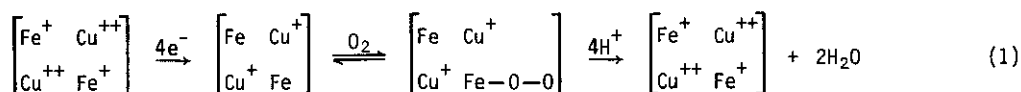

The four electrons are supplied in a very efficient way from the four separate reduced metal centers. Synthetic model systems for this reduction would, in principle, contain a group capable of supplying three electrons, this group being covalently attached to the hemein. (The porphyrin is represented as a square figure.)

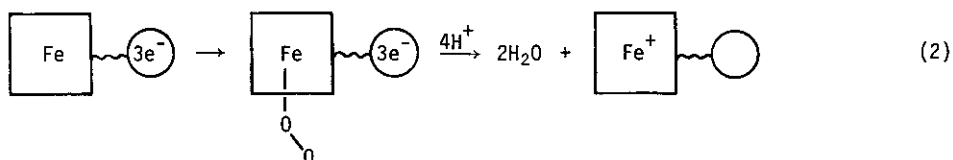

Most attempts to model either the spectroscopic or chemical properties of cytochrome c oxidase have involved the attachment of a second heme group or a copper chelate group to the heme.<sup>4-7</sup> The extra electrons must be supplied electrochemically or by some external reagent.

Horseradish peroxidase<sup>8</sup> and cytochrome c peroxidase<sup>9</sup> have an imidazole-protohemine complex as an active site and both react with hydrogen peroxide to oxidize their respective substrates. Horseradish peroxidase reacts with hydrogen peroxide or peracids to produce a two-electron oxidized species which is currently considered to be an Fe(IV)-porphyrin  $\pi$ -radical species as shown in equation 3.<sup>10</sup>

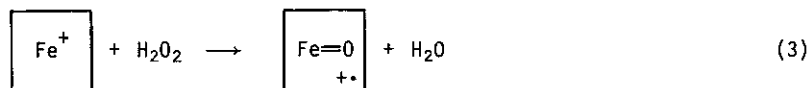

This species, referred to as "compound I" and often written as the "oxene" form,  $\text{Fe}^+=\text{O}$ , reacts rapidly with phenols and other organic compounds to transfer sequentially two electrons, returning to the starting Fe(III) state.<sup>8,9</sup>

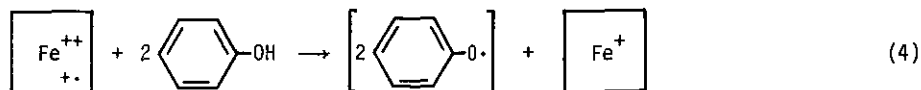

Model compounds<sup>11,12</sup> which show spectroscopic and catalytic activity similar to horseradish peroxidase are exemplified by chelated protohemin whose catalytic oxidation of tri-*t*-butylphenol is shown below.<sup>12a,b</sup>

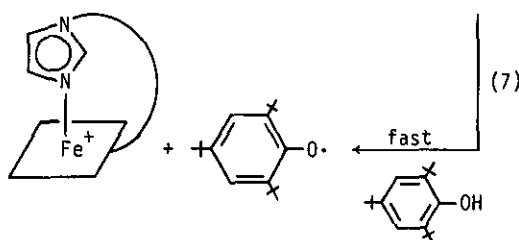
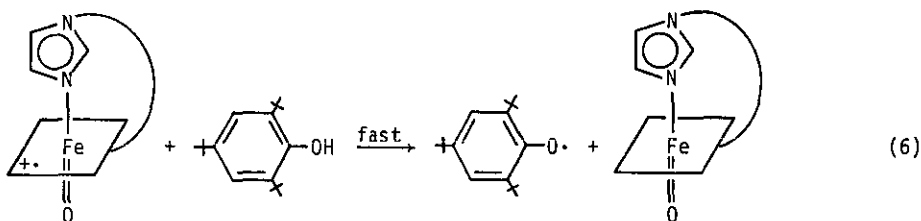
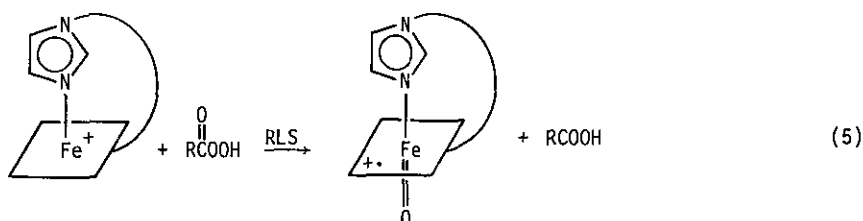

In this case the unstable intermediate is rapidly trapped by the phenol. Less reactive substrates such as olefins cannot compete with heme destruction and no oxidation product is produced. Tetraphenylhemin derivatives have been oxidized at low temperature to produce both a two-electron<sup>13</sup> oxidized and a one-electron oxidized hemin.<sup>14</sup> These intermediates show some of the chemical and spectroscopic properties of horseradish peroxidase intermediates I and II.

Cytochrome P-450 contains, in its resting state, protohemin attached to a protein thiolate ligand.<sup>15</sup> It is enzymatically reduced, adds dioxygen, and then another electron to produce a very reactive intermediate which can oxidize hydrocarbons to alcohols, benzenes to phenols, or olefins to epoxides.<sup>16</sup> These same oxidation processes can be accomplished by treating the Fe(III) protein with



The properties of this class of oxidized hemin compared to those of the Fe(IV)-porphyrin cation species and possible interconversion of the two types of species are considered.

To introduce electron density into the porphyrin orbitals, peripheral substituents having very negative  $\sigma^+$  values are required; extreme examples being NMe with  $\sigma^+ = -1.7$  and  $-O^-$  with a  $\sigma^+$  about  $-3$ .<sup>21</sup> The ability of these substituents to transfer electron density to the internal nitrogens is illustrated in Figure 1.

Electron-rich Porphyrins

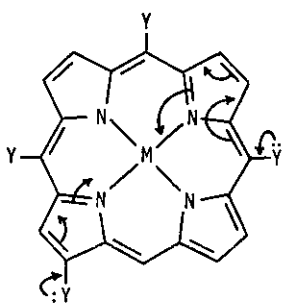

Stabilize high valent metal ions

"Polyvalent" Porphyrins

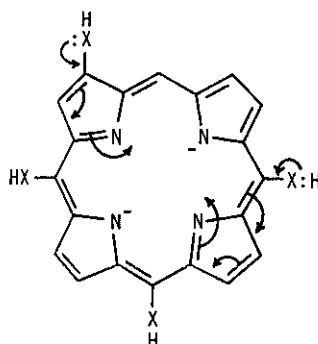

Supply zero to four charges to porphyrin center

Figure 1

We refer to porphyrins in which tautomerism exists between an external group and the internal nitrogen as polyvalent porphyrins because they have the potential of supplying zero to four electron charges to the internal nitrogens.<sup>20</sup> Two types of such tautomeric systems can be envisioned, an open tautomeric group and a fused ring system, illustrated with two examples below.

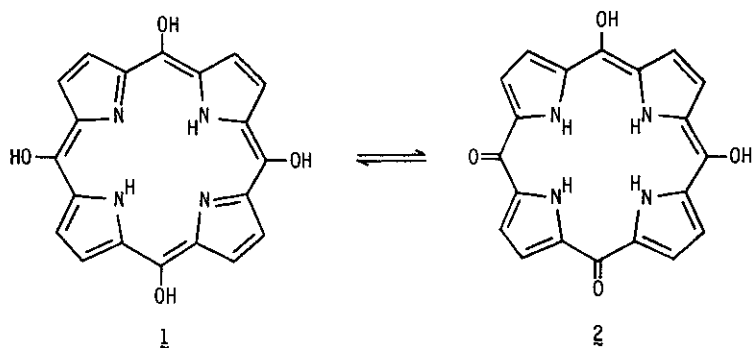

(13)

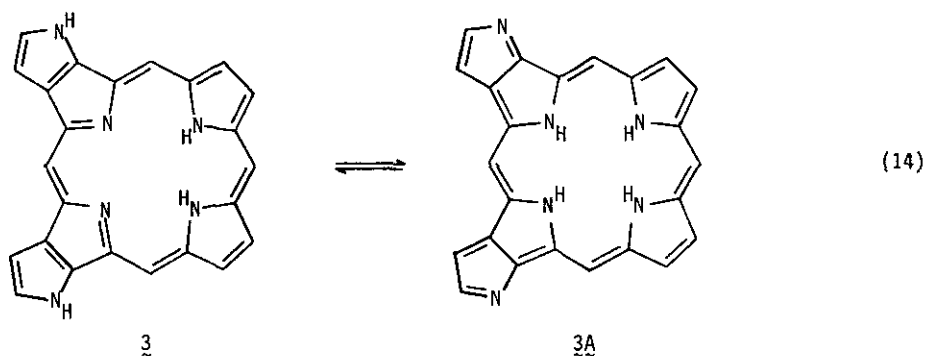

In the hydroxyporphyrin case the aromaticity is lost in the ketone form whereas in the fused ring system of equation 14 aromaticity is increased.

Such polyvalent systems have three possibly interesting and useful properties. First the tautomerism, discussed above, allows varying numbers of charges to be introduced into the core of the porphyrin, making possible the formation of neutral complexes with variously charged metals. Secondly the two ionizable substituents have the kind of resonance relationship found in hydroquinone and the disubstituted porphyrin might be expected to be easily oxidized to "quinone-like" structures (4).

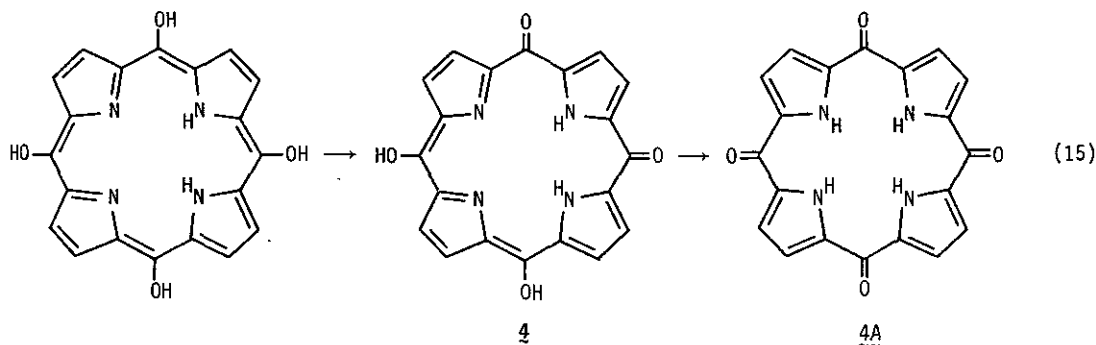

Both the tetrahydroxyporphyrin (2) and its two-electron oxidized form (4) have been prepared and studied.<sup>22,23</sup> The oxidized form was shown to exist in its tetraketo tautomer (4A).<sup>24</sup>

The third and perhaps most interesting aspect of the polyvalent porphyrins is the possibility of altering the oxidizing or reducing power of both the porphyrin and its metal complexes by changes in acidity of the medium. The internal oxidation reduction in metal complexes could be of special importance. Thus, Sano et al.<sup>25</sup> have shown that the iron(III) complex of hydroxyporphyrin is reduced to Fe(II) (and perhaps Fe(I)) by making the solution basic (equation 16).

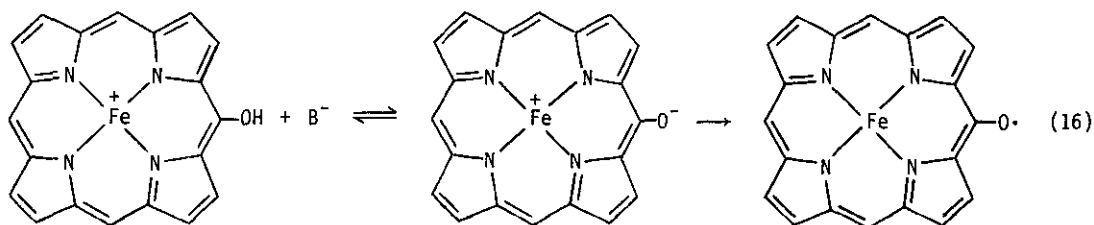

Alternatively, oxidized porphyrin complexes have the potential of becoming oxygen transfer reagents at high acidity.

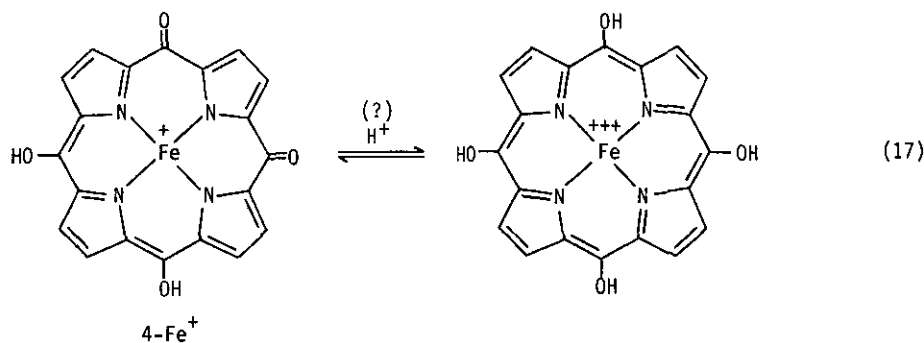

Thus a variation from very basic to very acidic media might afford strongly reducing or strongly oxidizing metal complexes.

Although mono- to tetrahydroxyporphyrins and aminoporphyrins have been studied in detail<sup>22</sup> in relation to heme degradation, they have certain properties which make them unsatisfactory as catalysts for oxygen reduction or substrate oxidation. The hydroxy or amino substituents can be substituted and the ring opens rather easily, especially in the oxidized form.<sup>22-25</sup>

We have attempted to avoid these degradations and to obtain stable porphyrins which could be oxidized, reduced, protonated and deprotonated by taking advantage of the steric protection of hydroxyphenol which allows stable phenoxyl radicals to be formed (see equation 6). We have prepared the known tetra(3,5-di-*t*-butyl-4-hydroxy)phenylporphyrin<sup>26,27</sup> by both the Rothmund<sup>28</sup> procedure and the standard acetic acid method<sup>29</sup> from the commercially available aldehyde and pyrrole. The porphyrin is best isolated and purified by treating the crude product with base and oxygen to produce the purple quinone form, purifying and storing this form and reducing it quantitatively to the porphyrin with sodium dithionite (see Scheme 1).

Scheme 1

## A Stable Polyvalent Porphyrin

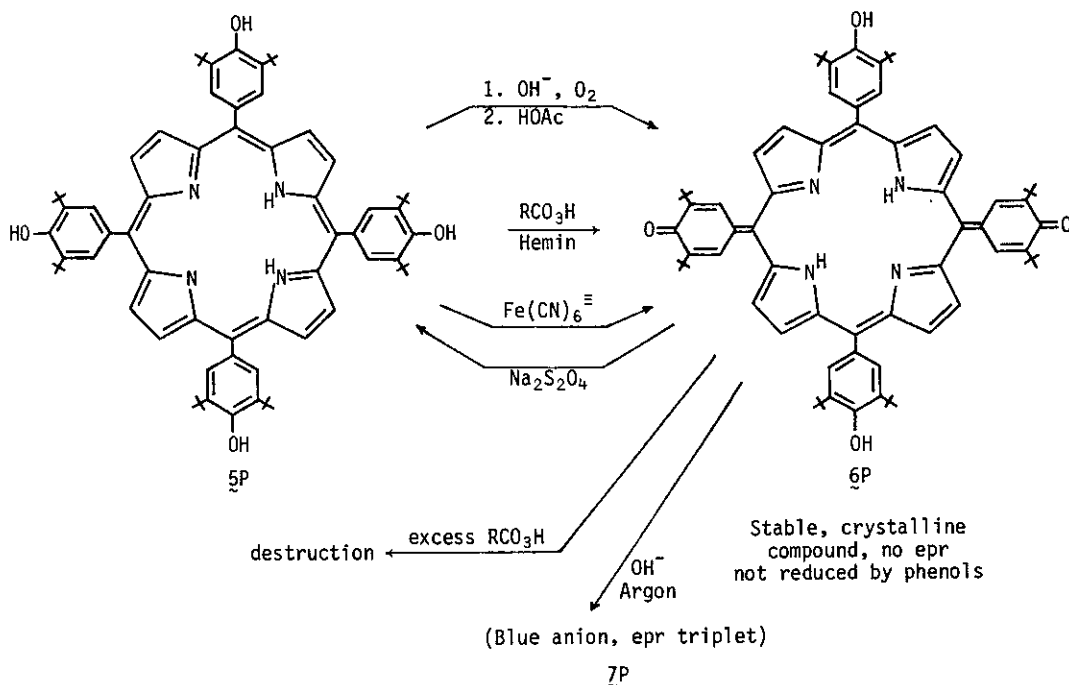

The porphyrin can also be oxidized by ferricyanide<sup>30</sup> or by the peracid-hemin system shown in equations 5 and 6. The peracid reaction is fast and titration with peracid revealed a consumption of one mole of peracid for oxidation of one porphyrin as shown in Scheme 1.

The oxidized porphyrin shows ketone and hydroxyl resonances in the infrared and has no epr spectrum, consistent with the formulation 6P shown. The oxidized form 6P reacts extremely slowly with *m*-cresol and is not reduced by cyclohexadiene. In strong base, the oxidized porphyrin forms a blue anion, 7P, which can be converted back to the original form by neutralization. The spectra of the porphyrin and its oxidized forms are shown in Figure 2.



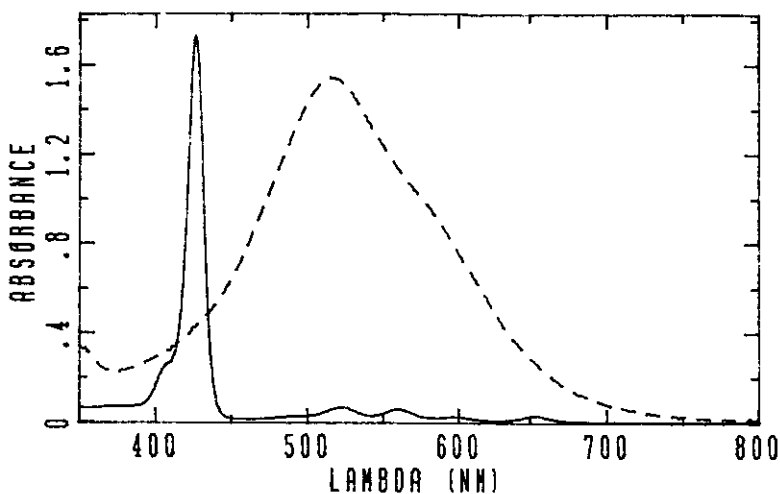
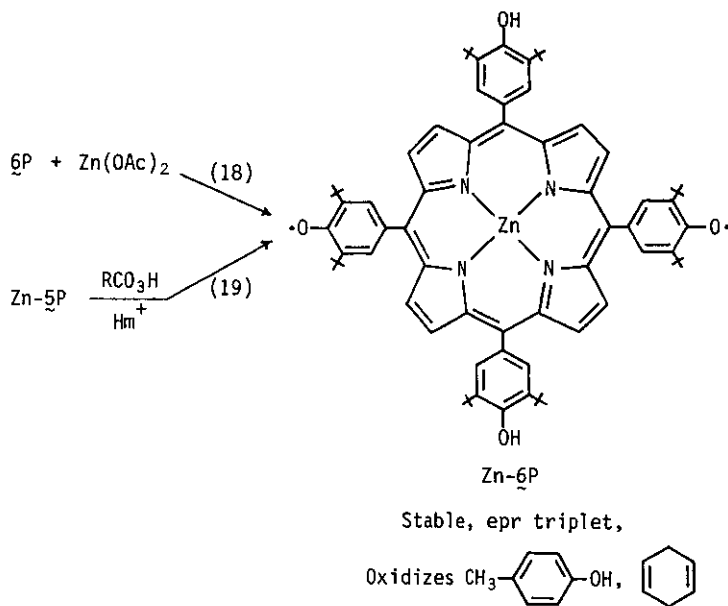

Figure 2. Spectra of purified oxidized tetra(3,5-di-t-butyl-4-hydroxylphenyl)porphyrin (6P) in  $\text{CHCl}_3$  (absorbance  $\times 4$ ) ---, and the porphyrin obtained upon addition of excess sodium dithionite (5P) —.

Treatment of the oxidized porphyrin with zinc acetate affords the two-electron oxidized zinc complex which displays an epr signal and rather rapidly oxidizes p-cresol or cyclohexadiene. The zinc complex Zn-6P was also obtained by two-electron oxidation of the zinc porphyrin Zn-5P (equations 18 and 19).



The iron(III) porphyrin, obtained by standard iron insertion, can be cleanly oxidized by two electron equivalents with *m*-chloroperbenzoic acid as shown in Scheme 2.

Scheme 2  
 $\text{Fe}^+$  Polyvalent Porphyrin

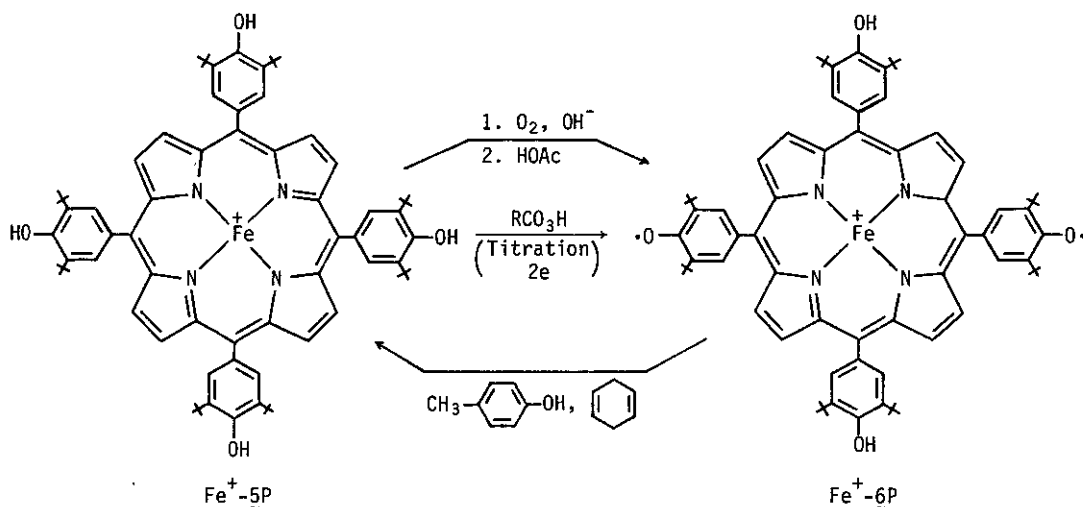

The same oxidized iron species is obtained by treating the iron(III) porphyrin  $\text{Fe}(\text{III})\text{-5P}$  with base in air followed by neutralization. The spectral changes are shown in Figure 3 and the transformations in Scheme 2.

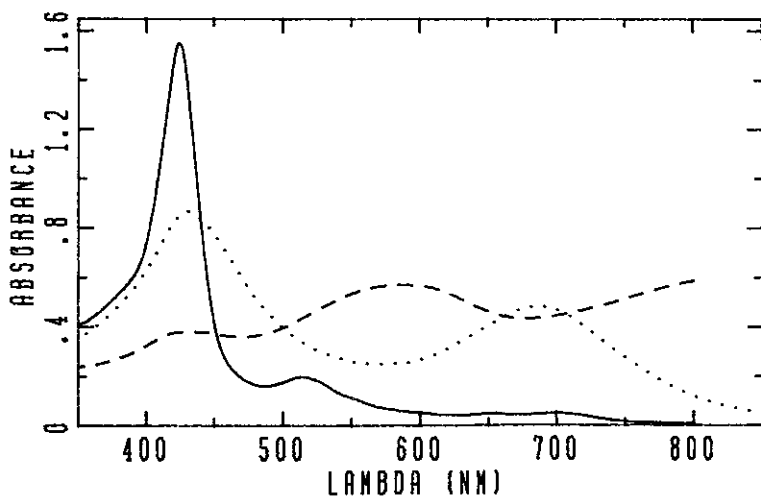

Figure 3. Spectra of the  $\text{Fe}(\text{III})$  porphyrin ( $\text{Fe}^+ \text{-5P}$ ) in 3 ml  $\text{CH}_2\text{Cl}_2$  —, after addition of 1 drop of 30% *t*-butylammonium hydroxide in air-saturated methanol ---, and after neutralizing with 3 drops of glacial acetic acid ( $\text{Fe}^+ \text{-6P}$ ) ...

Because the spectrum of the oxidized iron porphyrin is almost identical to that of the oxidized Zn complex Zn-6P we conclude that the iron has remained as iron(III) (see Figure 4).

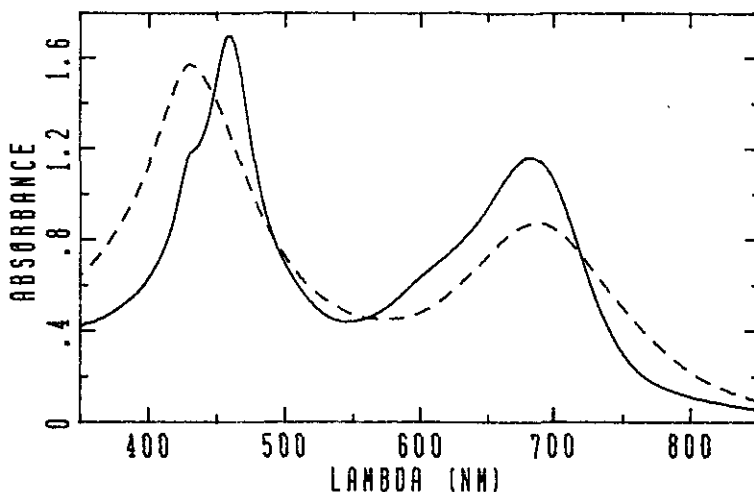

Figure 4. Spectra of the oxidized forms of the zinc porphyrin (Zn-6P) —, and the Fe(III) porphyrin (Fe<sup>+</sup>-6P) ---, both taken after oxidation with 1 molar equivalent of the *m*-chloroperbenzoic acid. Chelated protohemin was used as catalyst for the oxidation of the Zn porphyrin.

Nevertheless, the oxidized iron complex is reduced by *p*-cresol or cyclohexadiene indicating some peroxidase type activity. In all transformations, no heme loss was observed unless the heme was treated with a large excess of peracid.

Internal Oxidation Reduction. In order to demonstrate the self-reduction of the iron(III) porphyrin, a solution in methylene chloride was carefully degassed and treated with *N*-methylimidazole under anaerobic conditions. The Soret band at 428 nm and the visible bands at 536 and 570 nm were observed immediately, indicating rapid self-reduction. These were accompanied by the appearance of absorbances at 484 and 688 nm which are typical of phenoxyl radicals. These phenoxyl bands disappeared over a period of several hours.

Similar results were obtained in the presence of CO except that the spectrum of the MeIm-Heme-CO complex was observed. Spectral changes in the presence of CO are shown in Figure 5 and the sequence of changes in both experiments are shown in Schemes 3 and 4.

Figure 5. Spectra obtained by adding 1-methylimidazole to a solution of the hemin,  $\text{Fe}^+-5\text{P}$ , which had been purged with CO gas. Immediately after addition of 1-MeIm (visible absorbance  $\times 10$ ) —, two hours later (visible absorbance  $\times 5$ ) ---.

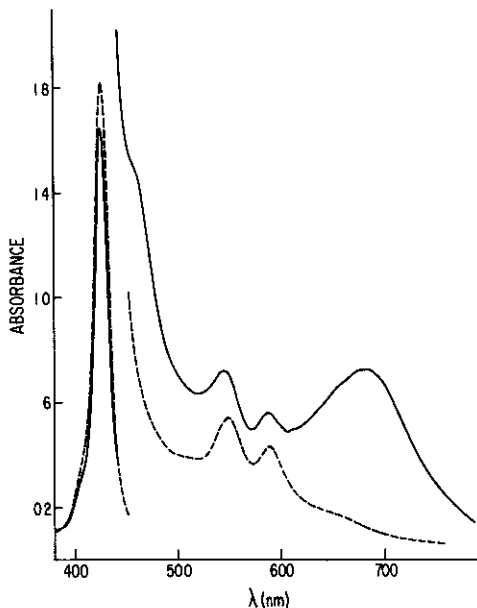

Scheme 3

Base-induced Self-reduction

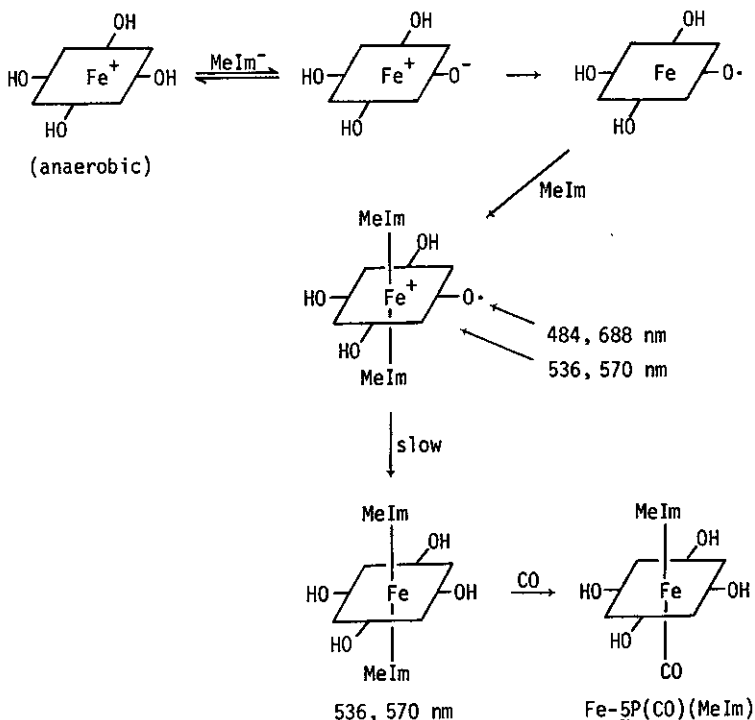

Scheme 4

Trapping Internal Oxidized-reduced Form

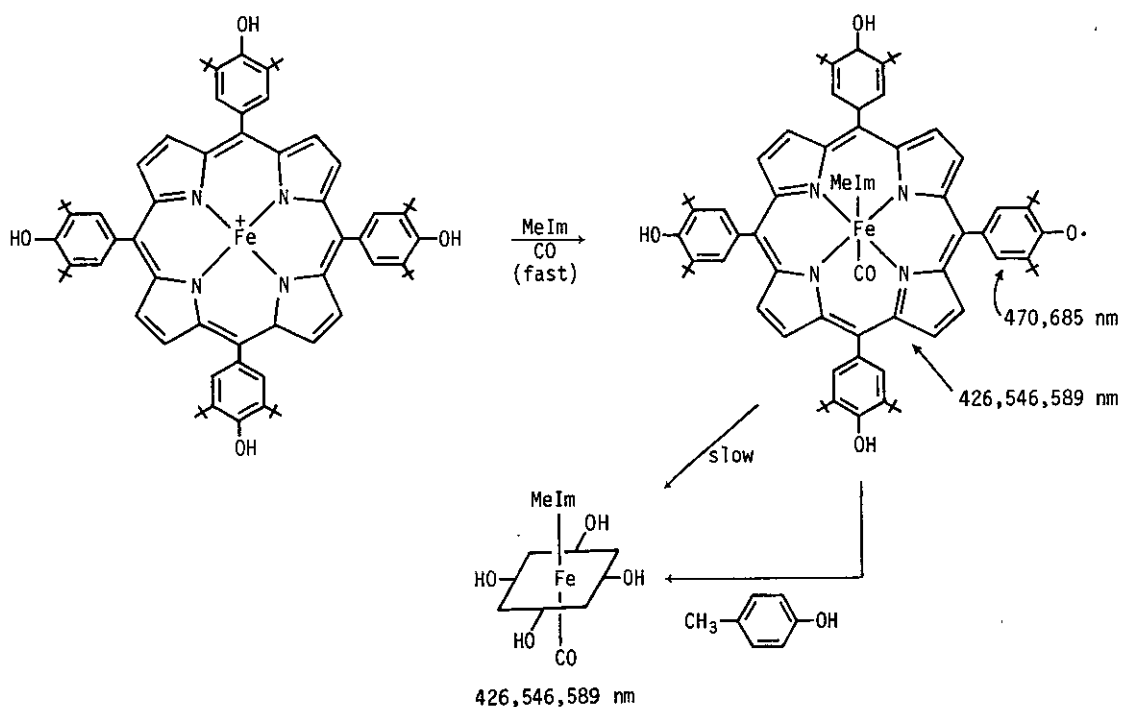

(More oxidizing species trapped by CO)

Since cresol was found to accelerate the disappearance of the phenoxyl absorbances, it seems clear that carbon monoxide has trapped a more strongly oxidizing species which was produced by internal reduction of Fe(III).

Dioxygen Reduction. Because CO traps the internally reduced Fe, similar trapping should occur with dioxygen.

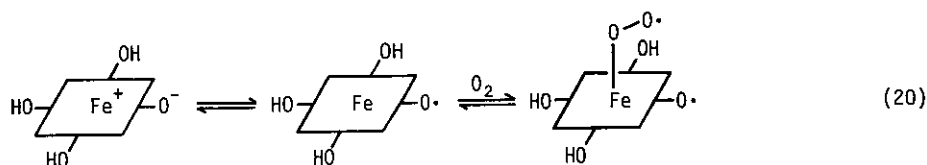

Treatment of an oxygen-saturated solution of the Fe(III) porphyrin, Fe<sup>+</sup>-5P, with base resulted in immediate production of a blue solution which, when neutralized, afforded the same green oxidized Fe(III) porphyrin which was obtained by oxidation with peracid.

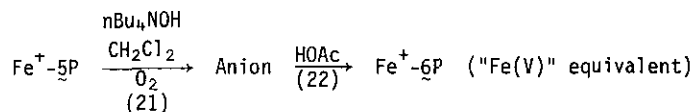

A possible mechanism for this reaction is shown below.

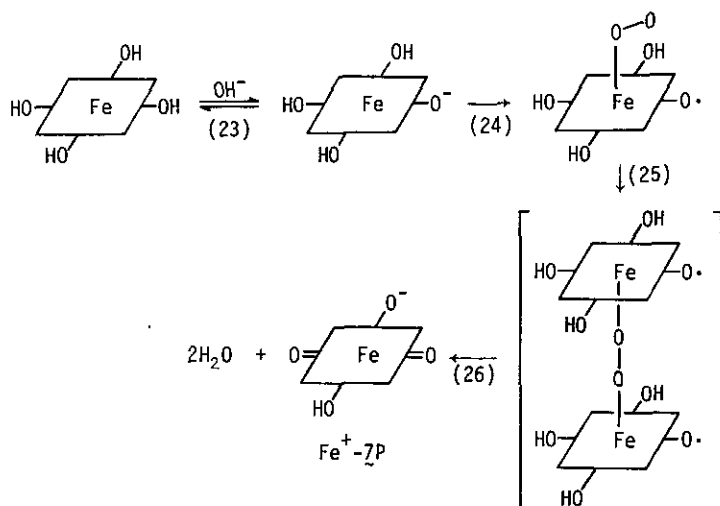

It is also possible that the phenoxide ion could electron transfer with dioxygen to yield superoxide ion which would react rapidly with Fe(III) to produce the same dioxygen complex shown in equation 23.

In strongly basic solutions the product of the dioxygen reaction is the anion  $\text{Fe}^+-7\text{P}$ . However, the oxidation also occurs in the presence of weaker bases such as 1-methylimidazole or triethylamine, leading directly to the more strongly oxidizing intermediate  $\text{Fe}^+-6\text{P}$ . Thus a catalytic oxidation becomes possible.

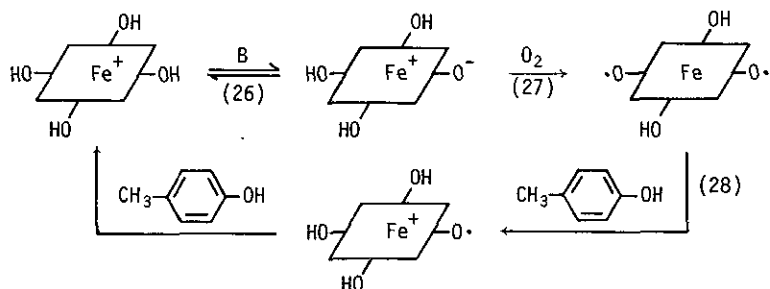

Further studies of the chemistry of iron complexes of polyvalent porphyrins are underway.

## ACKNOWLEDGMENT

We are grateful to the National Science Foundation, Grant CHE 81-20969, for support of this research.

## REFERENCES

1. F. Antonini and M. Brunori, 'Hemoglobin and Myoglobin in Their Reactions with Ligands,' North Holland, Amsterdam, 1971.
2. B. G. Malstrom, 'Metal Ion Activation of Dioxygen,' ed. T. G. Spiro, Wiley, 1980, ch. 5, p. 181; D. F. Wilson and M. Erecinska in 'The Porphyrins,' ed. D. Dolphin, Academic Press, 1979, vol. VII, ch. 1, p. 1.
3. B. E. Smith and P. F. Knowles in 'Inorganic Biochemistry. Specialist Periodical Report,' Senior Reporter H. A. O. Hill, The Chemical Society, London, 1979, ch. 7, p. 278.
4. C. K. Chang, M. S. Koo, and B. Ward, J. Chem. Soc., Chem. Commun., 1982, 716.
5. C. K. Chang in 'Biological and Clinical Aspects of Oxygen,' ed. W. S. Caughey, Academic Press, New York, 1979, p. 437-454.
6. M. J. Gunter, L. N. Mander, and K. S. Murray J. Chem. Soc., Chem. Commun., 1981, 799.
7. R. H. Petty and L. J. Wilson, J. Chem. Soc., Chem. Commun., 1978, 483; R. H. Petty, B. R. Welch, L. J. Wilson, L. A. Bottomley, and K. M. Kadish, J. Am. Chem. Soc., 1980, 102, 611.
8. H. B. Dunford and J. S. Stillman, Coord. Chem. Rev., 1976, 19, 187.
9. T. L. Poulos and J. Kraut, J. Biol. Chem., 1980, 255, 8199.
10. D. Dolphin, R. H. Felton, D. C. Borg, and J. Fajer, J. Am. Chem. Soc., 1970, 92, 743.
11. J. F. Drew and P. Jones, J. Inorg. Biochem., 1983, 18, 33; P. Jones, D. Mantle, D. M. Davies, and H. C. Kelly, Biochemistry, 1977, 16, 3974.
12. T. G. Traylor, W. A. Lee, and D. V. Stynes, J. Am. Chem. Soc., in press; T. G. Traylor, W. A. Lee, and D. V. Stynes in 'Bioorganic Studies on Receptor Sites,' ed. K. Nakanishi, Tetrahedron Symposium-in-Print, Pergamon, London, in press.
13. J. T. Groves, R. C. Haushalter, M. Nakamura, T. E. Nemo, and B. J. Evans, J. Am. Chem. Soc., 1981, 103, 2884.

14. D. H. Chin, J. Del Gaudio, G. N. La Mar, and A. L. Balch, J. Am. Chem. Soc., 1977, 99, 5486.
15. B. W. Griffin, J. A. Peterson, and R. W. Eastabrook, 'The Porphyrins,' ed. D. Dolphin, Academic Press, New York, 1978, pp. 333-377.
16. R. E. White and M. J. Coon, Ann. Rev. Biochem., 1980, 49, 315.
17. V. Ullrich, J. Mol. Catal., 1980, 7, 159.
18. J. T. Groves and G. A. McClusky in 'Biochemical and Clinical Aspects of Oxygen,' ed. W. S. Caughey, Academic Press, New York, 1979, pp. 277-310.
19. P. S. Traylor, D. Dolphin, T. G. Traylor, T. Nakano, and J. Marsters, unpublished work.
20. T. G. Traylor, K. B. Nolan, and R. Hildreth, J. Am. Chem. Soc., in press.
21. L. M. Stock and H. C. Brown in 'Advances in Physical Organic Chemistry,' ed. V. Gold, Academic Press, New York, Vol. I, 1963, pp. 35-154.
22. P. S. Clezy in 'The Porphyrins,' ed. D. Dolphin, Academic Press, New York, Vol. II, Part B, 1978, pp. 103-130.
23. H. Fischer and A. Stern in 'Die Chemie des Pyrrols,' Akad. Verlagsges, Leipzig, 1940, pp. 423-429.
24. H. H. Inhoffen, J. H. Furhop, and F. von der Haar, Justus Liebigs Ann. Chem., 1966, 700, 92.
25. S. Sano, Y. Sugiura, Y. Maeda, S. Ogawa, and I. Morishima, J. Am. Chem. Soc., 1981, 103, 2888.
26. A. L. W. Shroyer, C. Lorberau, S. S. Eaton, and G. R. Eaton, J. Org. Chem., 1980, 45, 4296.
27. A. V. Melezhik and V. D. Pokhodenko, Zh. Org. Khim., 1982, 18, 1054.
28. G. M. Badger, R. A. Jones, and R. L. Lawlett, Aust. J. Chem., 1964, 17, 1028.
29. J. B. Kim, A. D. Adler, and F. R. Longo in 'The Porphyrins,' ed. D. Dolphin, Academic Press, New York, Vol. 1, Part A, 1978, pp. 85-100.
30. This oxidation was reported in reference 28.